

# T-1 (3mm) PACKAGE SOLID STATE LAMP

# MVL-354TG

## Description

The MVL-354TG, a green source color device, is made with InGaN ( on SiC substrate) LED die.  
The package is T-1 (  $\phi$  3mm) water clear plastic type.

## Applications

- Full color displays & moving message signs
- Solid state incandescent replacement bulbs
- High ambient panel indicators
- Color printers & scanners
- Medical & Analytical instruments

## Features

- High performance - 1.5mW (525nm)
- Superior SiC substrate technology
- Excellent chip to chip consistency
- High reliability

## Package Dimensions

Unit: mm ( inches )

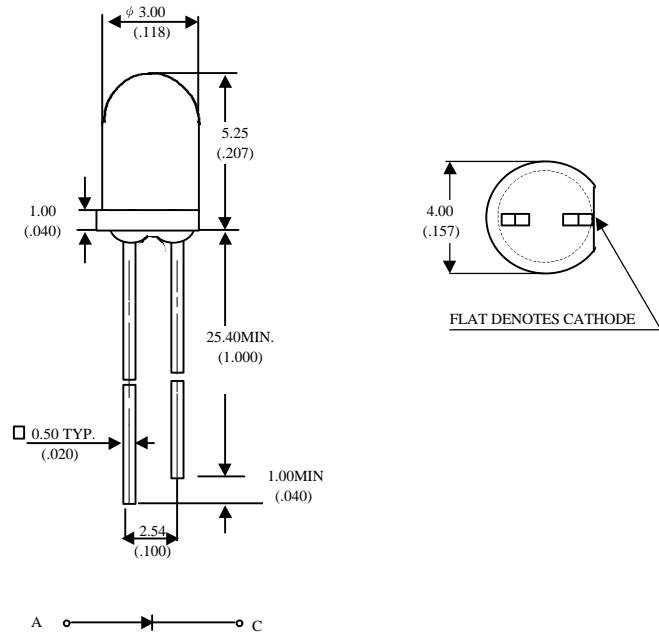

Notes :

1. Tolerance is  $\pm 0.25$  mm (.010") unless otherwise noted.
2. Protruded resin under flange is 0.8 mm (.031") max.
3. Lead spacing is measured where the leads emerge from the package.

## Absolute Maximum Ratings

@  $T_A = 25^\circ\text{C}$

Parameter	Symbol	Maximum Rating	Unit
Peak Forward Current(1/10 Duty Cycle@1KHz )	$I_{pf}$	100	mA
Continuous Forward Current	$I_{af}$	30	mA
Reverse Voltage	$V_R$	5	V
Operating Temperature Range	$T_{opr}$	-20 $^\circ\text{C}$ to +80 $^\circ\text{C}$	
Storage Temperature Range	$T_{stg}$	-30 $^\circ\text{C}$ to +100 $^\circ\text{C}$	
Electrostatic Discharge Threshold(HBM)	$E_{ot}$	1000	V

**UNI**

Unity Opto Technology Co., Ltd.

08/25/2000

Optical-Electrical Characteristics

@ T<sub>A</sub>=25 °C

Parameter	Test Conditions	Symbol	Min .	Typ .	Max .	Unit .
Luminous Intensity	I <sub>F</sub> =20mA	I <sub>V</sub>	500	1100	-	mcd
Forward Voltage	I <sub>F</sub> =20mA	V <sub>F</sub>	-	3.5	4.0	V
Reverse Current	V <sub>R</sub> =5V	I <sub>R</sub>	-	-	10	μA
Dominant Wavelength	I <sub>F</sub> =20mA	λ <sub>d</sub>	-	525	-	nm
Viewing Angle	I <sub>F</sub> =20mA	2θ <sub>1/2</sub>	-	30	-	deg.

Typical Optical-Electrical Characteristic Curves

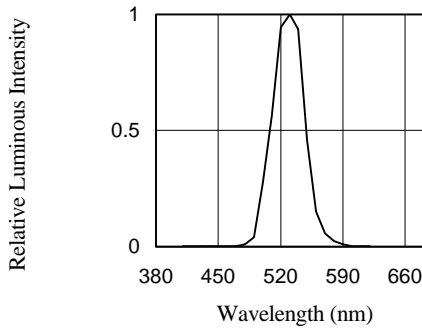

FIG.1 RELATIVE INTENSITY LUMINOUS VS. WAVELENGTH

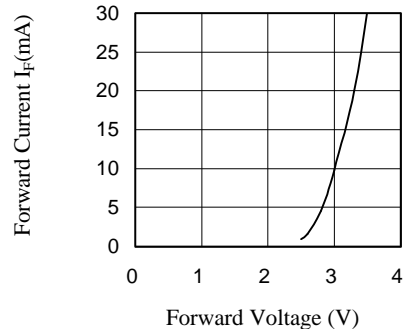

FIG.2 FORWARD CURRENT I<sub>F</sub>(mA) VS. FORWARD VOLTAGE

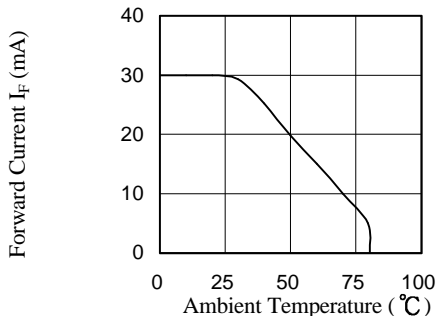

FIG.3 FORWARD CURRENT I<sub>F</sub>(mA) VS. AMBIENT TEMPERATURE

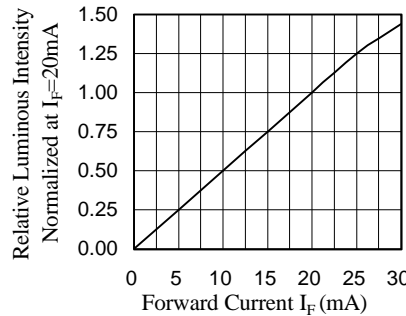

FIG.4 RELATIVE LUMINOUS INTENSITY VS. FORWARD CURRENT

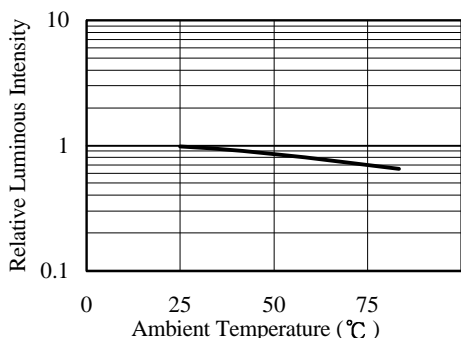

FIG.5 LUMINOUS INTENSITY VS. AMBIENT TEMPERATURE

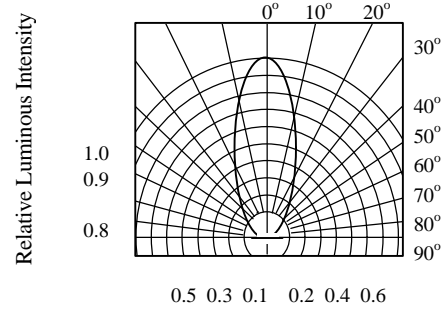

FIG.6 RADIATION DIAGRAM