

Transistors

2SB1116

AUDIO FREQUENCY POWER AMPLIFIER MEDIUM SPEED SWITCHING

ABSOLUTE MAXIMUM RATINGS ($T_a = 25^\circ\text{C}$)

Characteristic	Symbol	Rating	Unit
Collector-Base Voltage	V_{CBO}	-60	V
Collector-Emitter Voltage	V_{CEO}	-50	V
Emitter-Base Voltage	V_{EBO}	-6	V
Collector Current (DC)	I_C	-1	A
*Collector Current (Pulse)	I_C	-2	A
Collector Dissipation	P_C	0.75	W
Junction Temperature	T_j	150	$^\circ\text{C}$
Storage Temperature	T_{stg}	-55~150	$^\circ\text{C}$

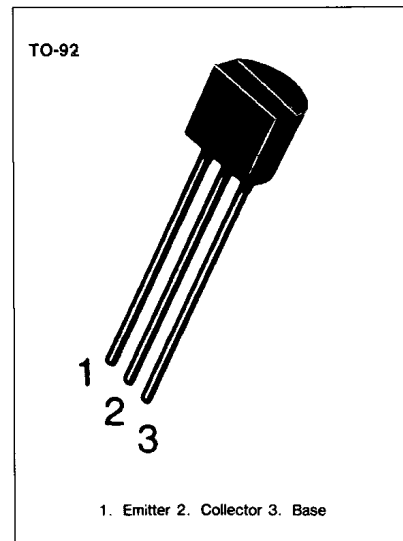

* $PW \leq 10\text{ms}$, Duty Cycle $\leq 50\%$

ELECTRICAL CHARACTERISTICS ($T_a = 25^\circ\text{C}$)

Characteristic	Symbol	Test Conditions	Min	Typ	Max	Unit
Collector Cutoff Current	I_{CBO}	$V_{CB} = -60\text{V}$, $I_E = 0$			-100	nA
Emitter Cutoff Current	I_{EBO}	$V_{EB} = -6\text{V}$, $I_C = 0$			-100	nA
*DC Current Gain	h_{FE1}	$V_{CE} = -2\text{V}$, $I_C = -100\text{mA}$	135		600	
	h_{FE2}	$V_{CE} = -2\text{V}$, $I_C = -1\text{A}$	81			
* Base Emitter On Voltage	$V_{BE}(\text{on})$	$V_{CE} = -2\text{V}$, $I_C = -50\text{mA}$	-600	-650	-700	mV
* Collector Emitter Saturation Voltage	$V_{CE}(\text{sat})$	$I_C = -1\text{A}$, $I_B = -50\text{mA}$		-0.2	-0.3	V
* Base Emitter Saturation Voltage	$V_{BE}(\text{sat})$	$I_C = -1\text{A}$, $I_B = -50\text{mA}$		-0.9	-1.2	V
Output Capacitance	C_{ob}	$V_{CB} = -10\text{V}$, $I_E = 0$ $f = 1\text{MHz}$		25		pF
Current Gain Bandwidth Product	f_T	$V_{CE} = -2\text{V}$, $I_C = -100\text{mA}$	70	120		MHz
Turn On Time	t_{on}	$V_{CC} = -10\text{V}$, $I_C = -100\text{mA}$		0.07		μs
Storage Time	t_s	$I_{B1} = -I_{B2} = -10\text{mA}$		0.7		μs
Fall Time	t_f	$V_{BE}(\text{off}) = 2\sim 3\text{V}$		0.07		μs

* Pulse Test: $PW \leq 350\mu\text{s}$, Duty Cycle $\leq 2\%$ Pulsed

$h_{FE}(1)$ CLASSIFICATION

Classification	Y	G	L
$h_{FE}(1)$	135-270	200-400	300-600



STATIC CHARACTERISTIC

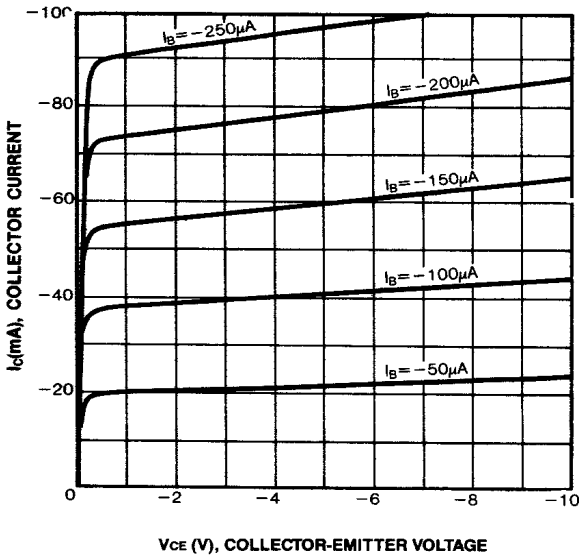

STATIC CHARACTERISTIC

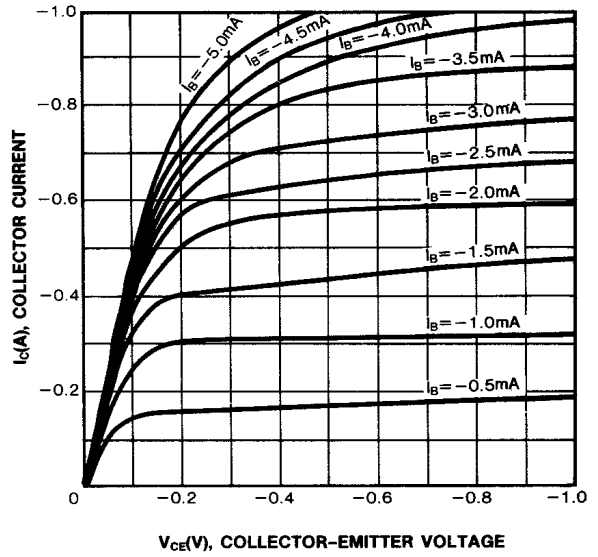

DC CURRENT GAIN

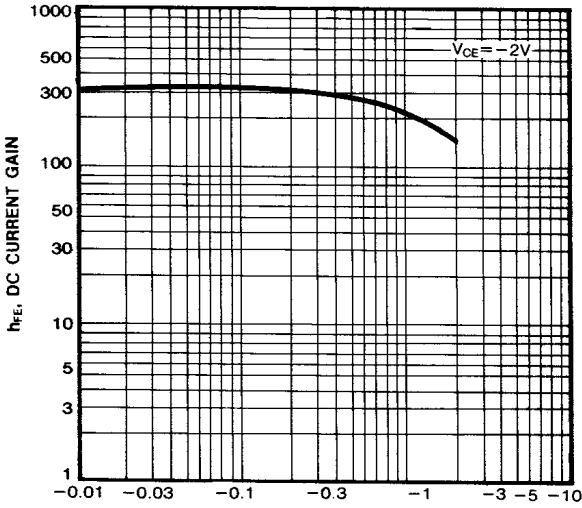

**BASE-EMITTER SATURATION VOLTAGE
COLLECTOR-EMITTER SATURATION VOLTAGE**

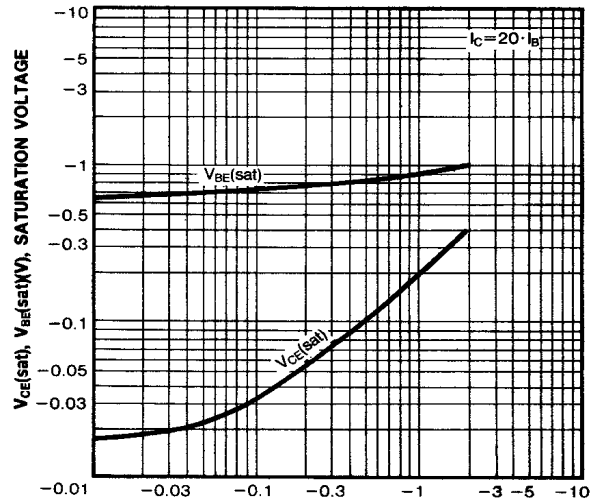

SAFE OPERATING AREA

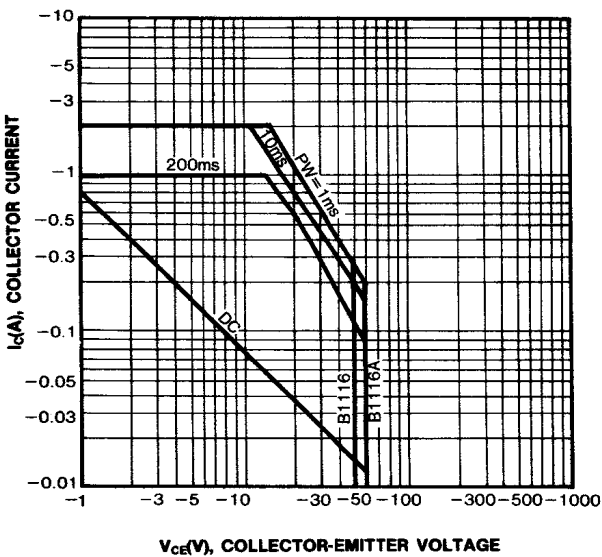

POWER DERATING

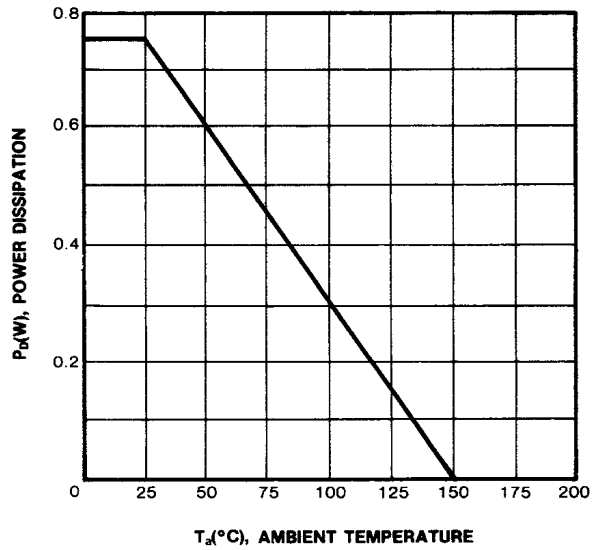

COLLECTOR OUTPUT CAPACITANCE

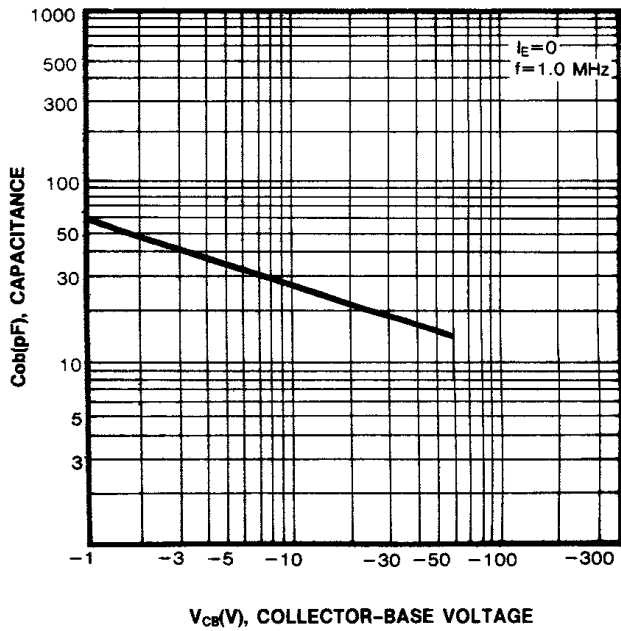

CURRENT GAIN-BANDWIDTH PRODUCT

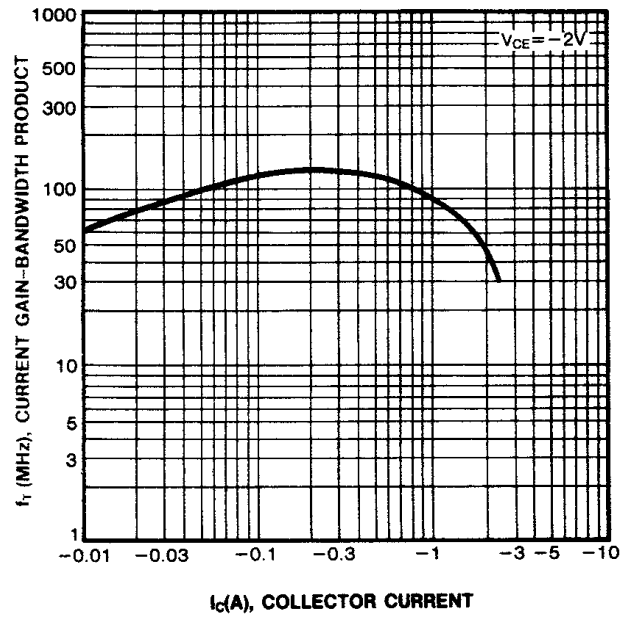

SWITCHING TIME

