

# Transistors

## 2SC1674

### TV PIF AMPLIFIER, FM TUNER RF AMPLIFIER, MIXER, OSCILLATOR

- High Current-Gain-Bandwidth Product  $f_T = 600\text{MHz}$  (Typ)
- High Power Gain  $G_{pe} = 22\text{dB}$  at  $f = 100\text{MHz}$

### ABSOLUTE MAXIMUM RATINGS ( $T_a = 25^\circ\text{C}$ )

Characteristic	Symbol	Rating	Unit
Collector-Base Voltage	$V_{CBO}$	30	V
Collector-Emitter Voltage	$V_{CEO}$	20	V
Emitter-Base Voltage	$V_{EBO}$	4	V
Collector Current	$I_C$	20	mA
Collector Dissipation	$P_C$	250	mW
Junction Temperature	$T_j$	150	$^\circ\text{C}$
Storage Temperature	$T_{stg}$	-55 ~ 150	$^\circ\text{C}$

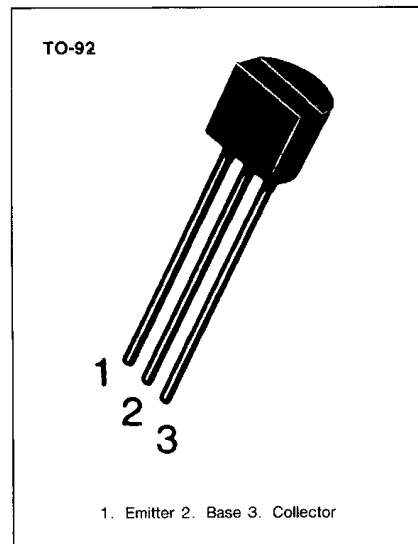

### ELECTRICAL CHARACTERISTICS ( $T_a = 25^\circ\text{C}$ )

Characteristic	Symbol	Test Conditions	Min	Typ	Max	Unit
Collector-Base Breakdown Voltage	$BV_{CBO}$	$I_C = 10\mu\text{A}, I_E = 0$	30			V
Collector-Emitter Breakdown Voltage	$BV_{CEO}$	$I_C = 5\text{mA}, I_B = 0$	20			V
Emitter-Base Breakdown Voltage	$BV_{EBO}$	$I_E = 10\mu\text{A}, I_C = 0$	4			V
Collector Cut-off Current	$I_{CBO}$	$V_{CB} = 30\text{V}, I_E = 0$			0.1	$\mu\text{A}$
Emitter Cut-off Current	$I_{EBO}$	$V_{EB} = 4\text{V}, I_C = 0$			0.1	$\mu\text{A}$
DC Current Gain	$h_{FE}$	$V_{CE} = 6\text{V}, I_C = 1\text{mA}$	40		240	
Base-Emitter On Voltage	$V_{BE}(\text{on})$	$V_{CE} = 6\text{V}, I_C = 1\text{mA}$		0.72		V
Collector-Emitter Saturation Voltage	$V_{CE}(\text{sat})$	$I_C = 10\text{mA}, I_B = 1\text{mA}$		0.1	0.3	V
Current-Gain-Bandwidth Product	$f_T$	$V_{CE} = 6\text{V}, I_C = 1\text{mA}$	400	600		MHz
Output Capacitance	$C_{ob}$	$V_{CB} = 6\text{V}, I_E = 0$ $f = 1\text{MHz}$		1.2		pF
Collector-Base Time Constant	$C_c r_{bb'}$	$V_{CE} = 6\text{V}, I_E = 1\text{mA}$ $f = 31.9\text{MHz}$		12	15	ps
Common Source Noise Figure	NF	$V_{CE} = 6\text{V}, I_E = 1\text{mA}$ $R_S = 50\Omega, f = 100\text{MHz}$		3.0	5.0	dB
Power Gain	$G_{pe}$	$V_{CE} = 6\text{V}, I_E = 1\text{mA}$ $R_S = 50\Omega, f = 100\text{MHz}$ (Typ)	18	22		dB

### $h_{FE}$ CLASSIFICATION

Classification	R	O	Y
$h_{FE}$	40-80	70-140	120-240



**STATIC CHARACTERISTIC**

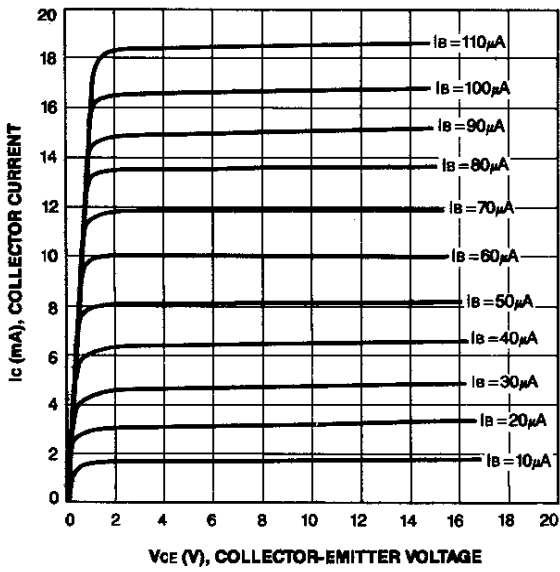

**BASE-EMITTER ON VOLTAGE**

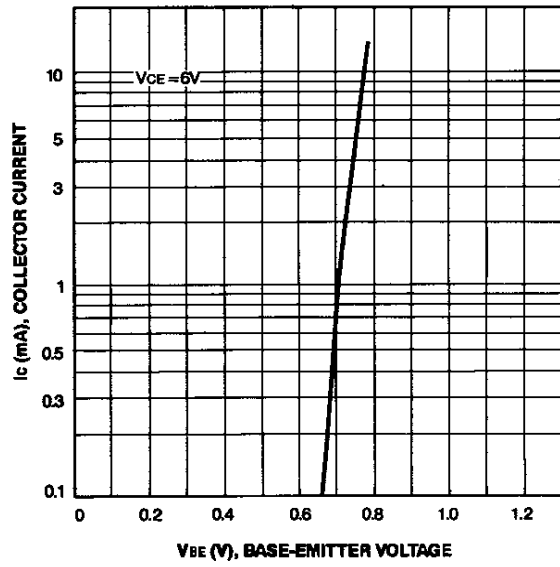

**DC CURRENT GAIN**

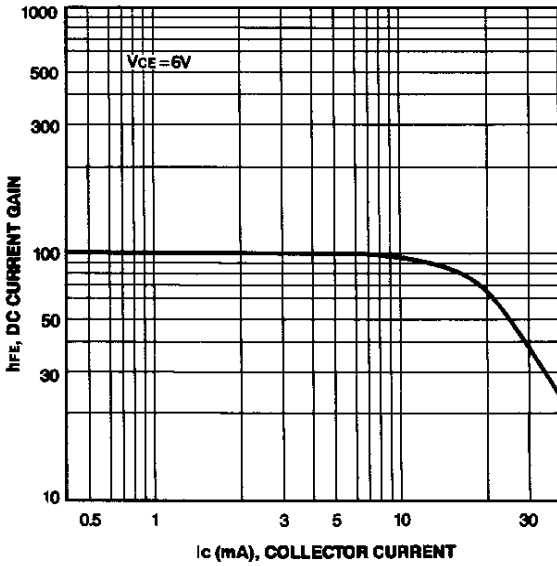

**CURRENT GAIN-BANDWIDTH PRODUCT**

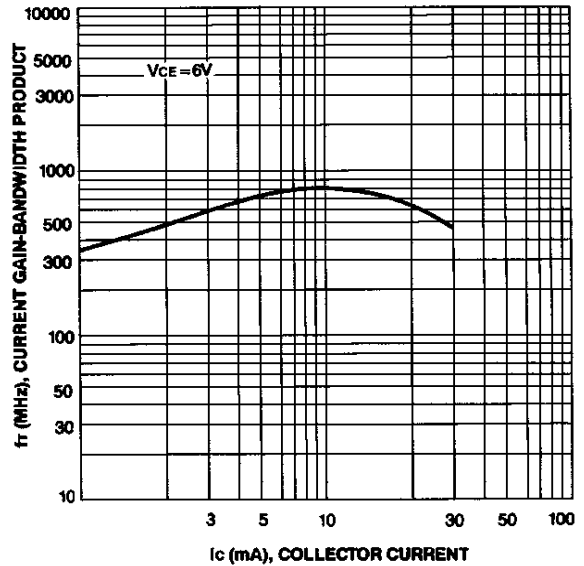

**BASE-EMITTER SATURATION VOLTAGE  
COLLECTOR-EMITTER SATURATION VOLTAGE**

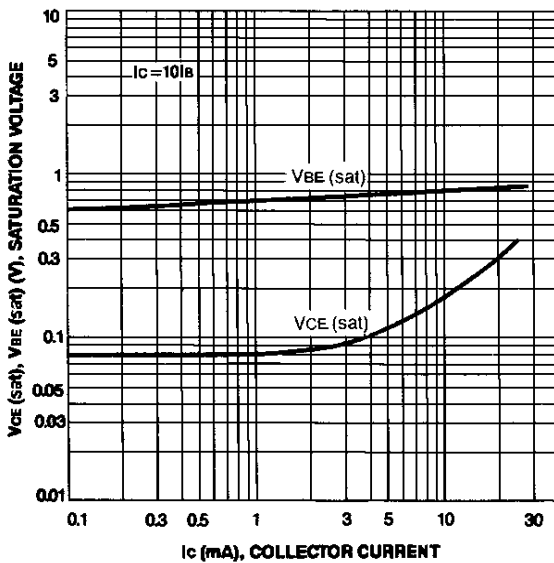

**COLLECTOR OUTPUT CAPACITANCE**

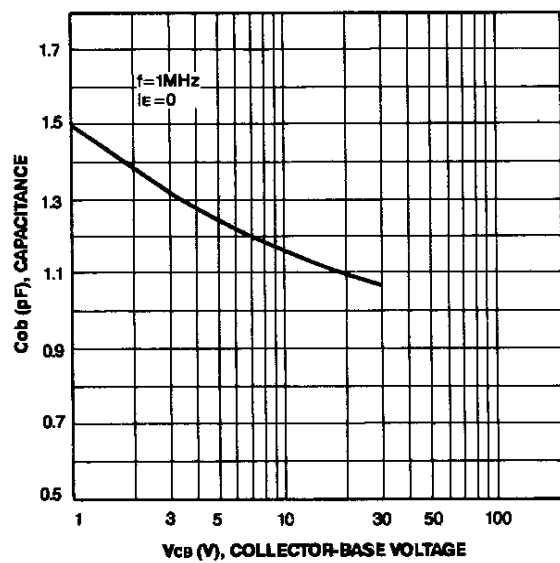

**INPUT ADMITTANCE ( $y_{ie}$ )  
vs. COLLECTOR CURRENT**

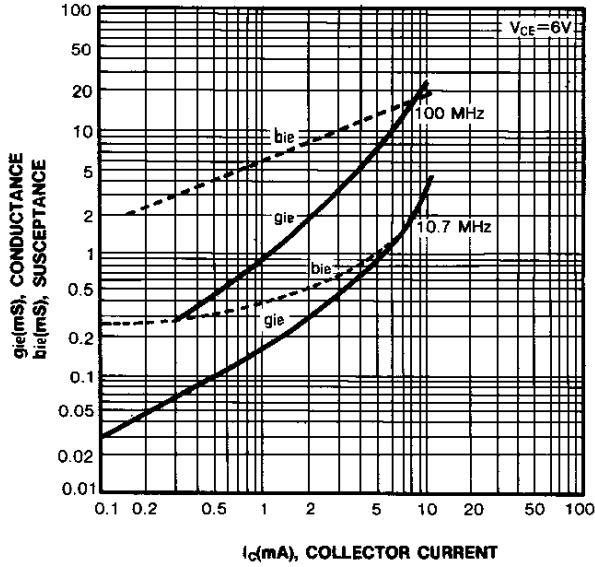

**FORWARD TRANSFER ADMITTANCE ( $y_{fe}$ )  
vs. COLLECTOR CURRENT**

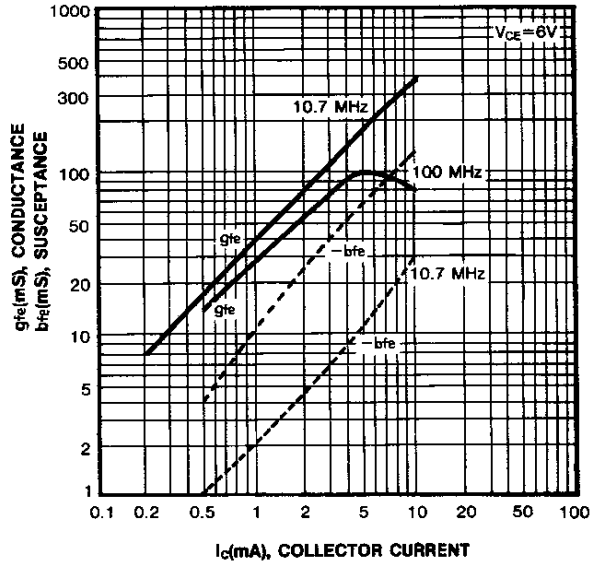

**REVERSE TRANSFER ADMITTANCE ( $y_{re}$ )  
vs. COLLECTOR CURRENT**

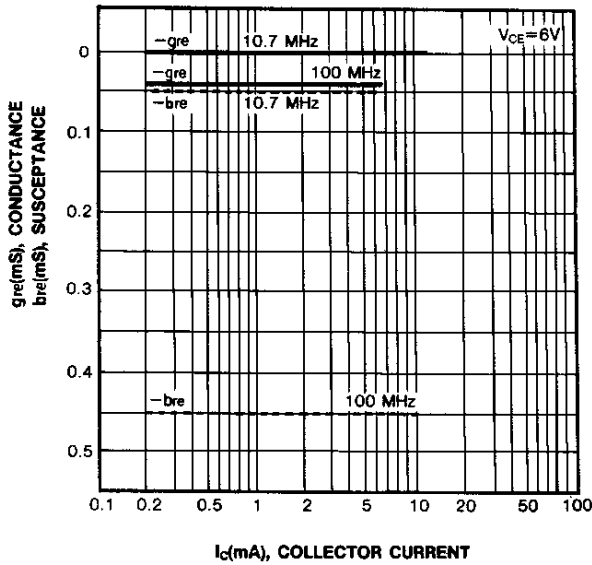

**OUTPUT ADMITTANCE ( $y_{oe}$ )  
vs. COLLECTOR CURRENT**

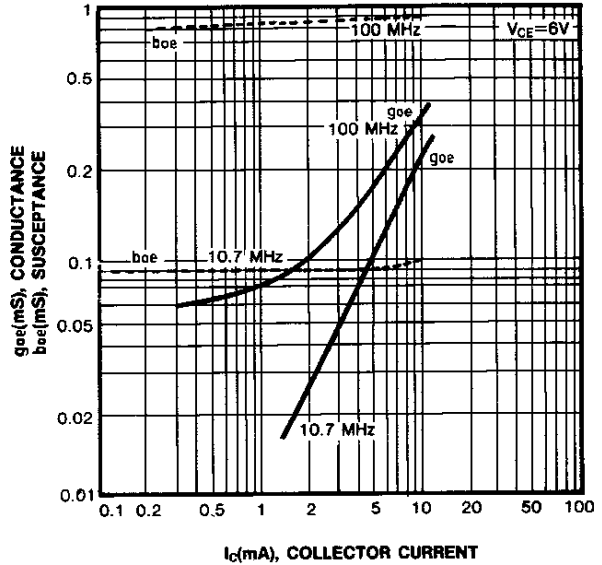

**INPUT ADMITTANCE ( $y_{ib}$ ) vs. COLLECTOR CURRENT**

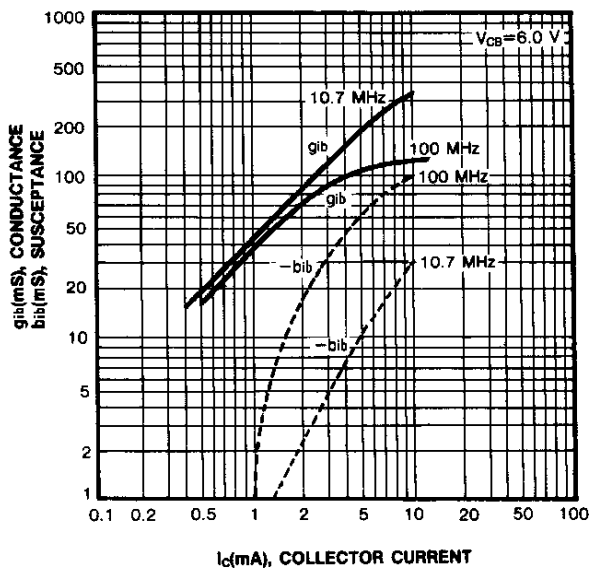

**FORWARD TRANSFER ADMITTANCE ( $y_{fb}$ )  
vs. COLLECTOR CURRENT**

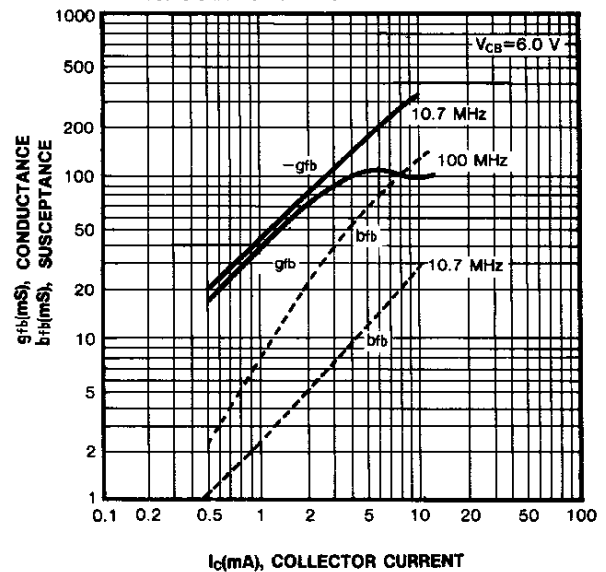

**REVERSE TRANSFER ADMITTANCE ( $y_{rb}$ ) vs. COLLECTOR CURRENT**

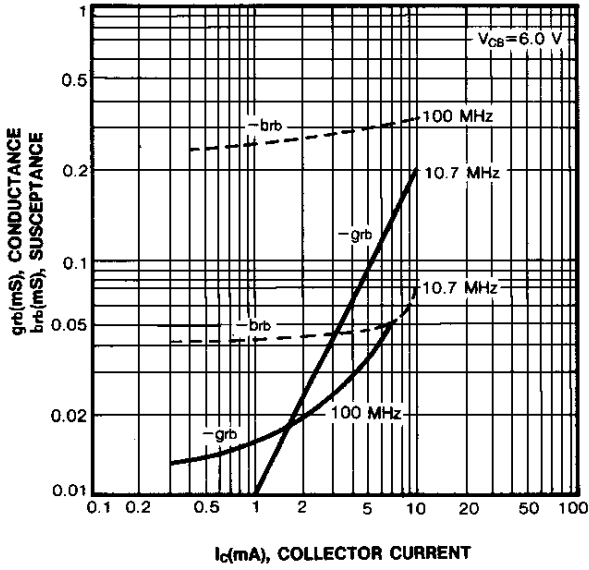

**REVER TRANSFER ADMITTANCE ( $y_{re}$ ) vs. FREQUENCY**

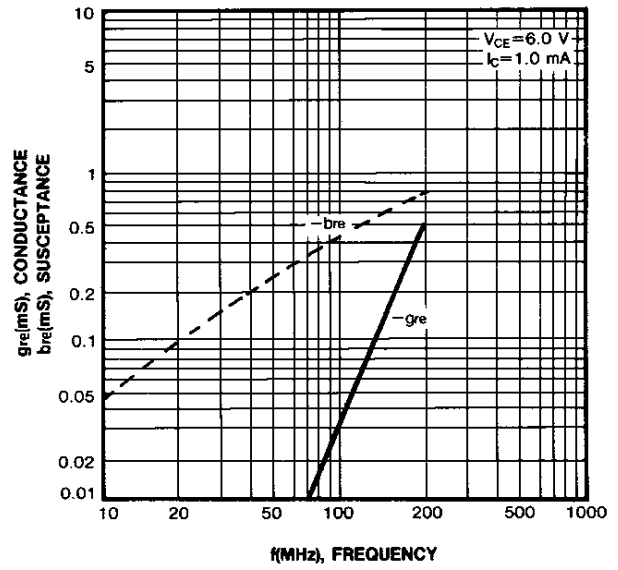

**FORWARD TRANSFER ADMITTANCE ( $y_{fe}$ ) vs. FREQUENCY**

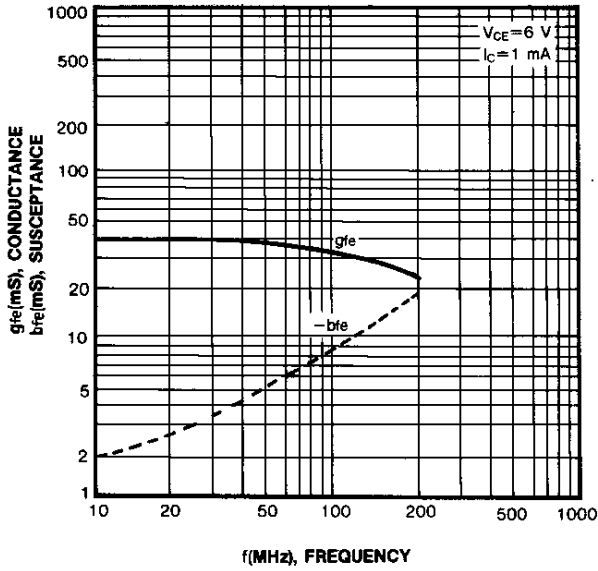

**OUTPUT ADMITTANCE ( $y_{oe}$ ) vs. FREQUENCY**

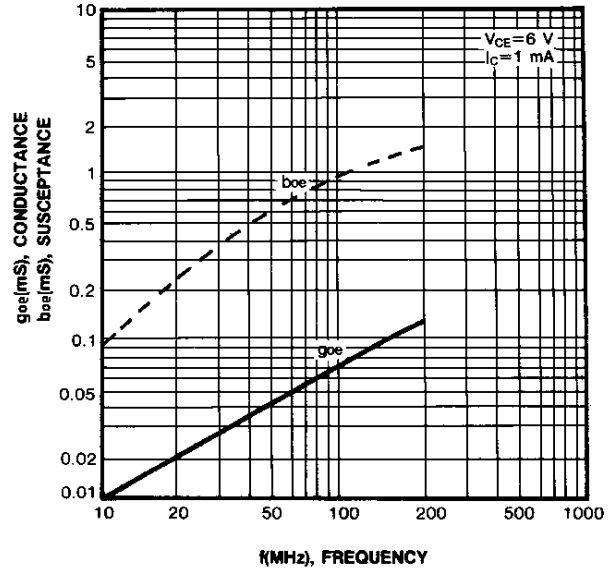

**POWER GAIN AND NOISE FIGURE vs. EMITTER CURRENT**

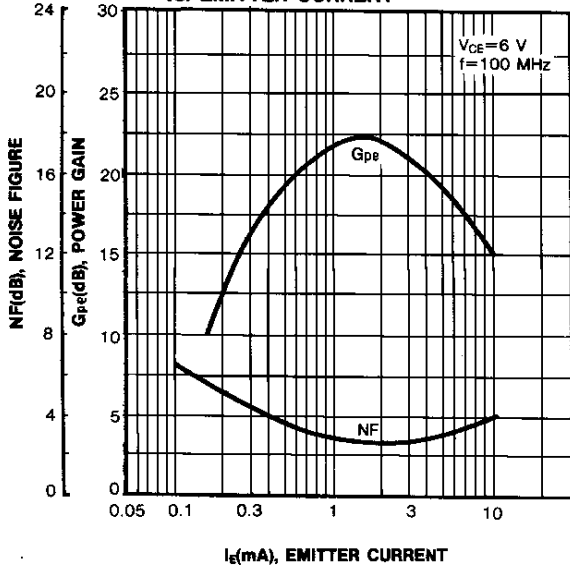

**INPUT ADMITTANCE ( $y_{ie}$ ) vs. FREQUENCY**

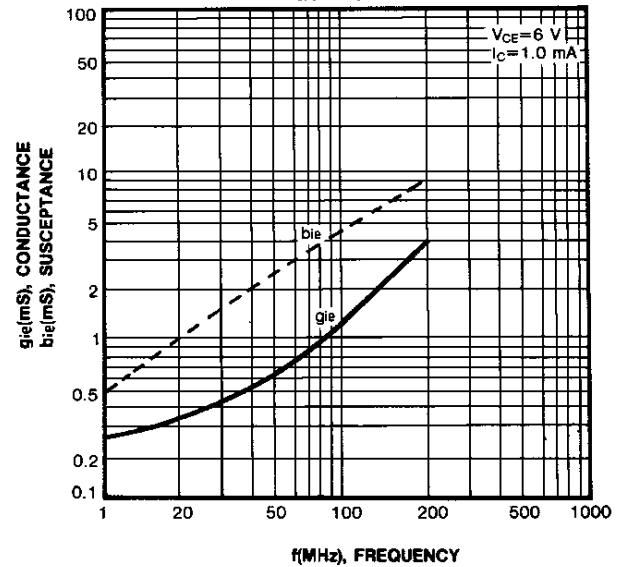

### 100MHz $G_{pe}$ , NF TEST CIRCUIT

