

Thyristors

T130



Technical Data

Typical applications : D.C. Motor control, Controlled rectifiers, A.C. Controllers

Type No.	V_{RRM} (Volts)	V_{RSM} (Volts)
T130/04	400	500
T130/06	600	700
T130/08	800	900
T130/10	1000	1100
T130/12	1200	1300
T130/14	1400	1500
T130/16	1600	1700

Features

- Hermetic glass to metal seal
- Voltage grade upto 1600V
- Weight 210 gm (Approx)

Symbol	Conditions	Values
$I_{T(AV)}$	Sin 180 ; $T_{case} = 85^{\circ}C$	130 A
I_{TSM}	$T_{vj} = 25^{\circ}C$ $T_{vj} = 130^{\circ}C$	3500 A 3000 A
I^2t	$T_{vj} = 25^{\circ}C$ $T_{vj} = 130^{\circ}C$	61000 A ² s 45000 A ² s
I_{GT} V_{GT} dv/dt $[di/dt]_{CR}$	$T_{vj} = 25^{\circ}C$; $V_{DRM} = 5V$ $T_{vj} = 25^{\circ}C$; $V_{DRM} = 5V$ $T_{vj} = 125^{\circ}C$; Voltage = 67 % V_{DRM}	200 mA 3 V *200 V/us 100 A/us
V_T V_0 R_0 I_{RRM}/I_{DRM}	$T_{vj} = 25^{\circ}C$; $I_T = 500A$ $T_{vj} = 130^{\circ}C$ $T_{vj} = 130^{\circ}C$ $T_{vj} = 130^{\circ}C$	2.25 V max 1.20 V 2.2 m 50 mA
I_H I_L		Typ 150 mA; max. 250 mA Typ 300 mA; max. 600 mA
$R_{th(j-c)}$ $R_{th(c-h)}$ T_{vj} T_{stg}	Cont. Sin 180 / rec. 120	0.16 $^{\circ}C/W$ 0.18 / 0.20 $^{\circ}C/W$ 0.03 $^{\circ}C/W$ + 130 $^{\circ}C$ -40.....+ 150 $^{\circ}C$
Mounting torque		30 Nm
Case outline		X

* Higher dv/dt selection available on request



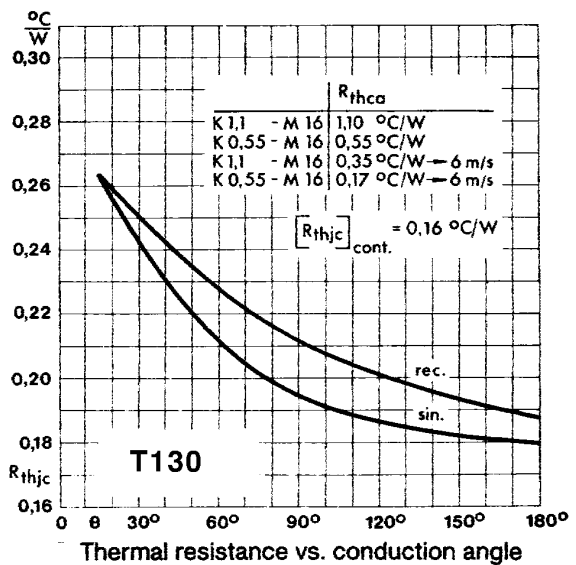
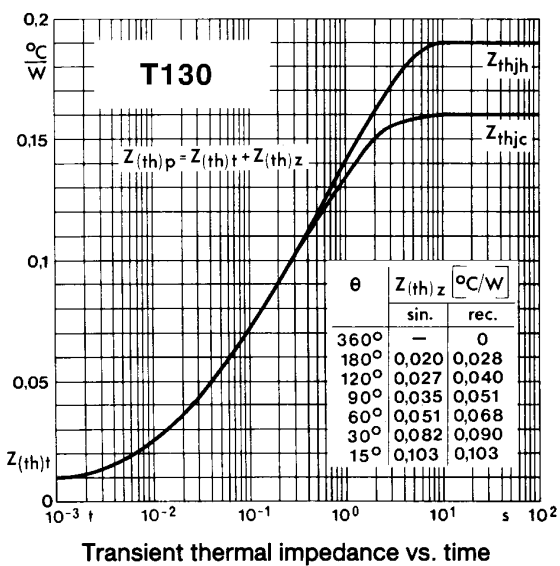
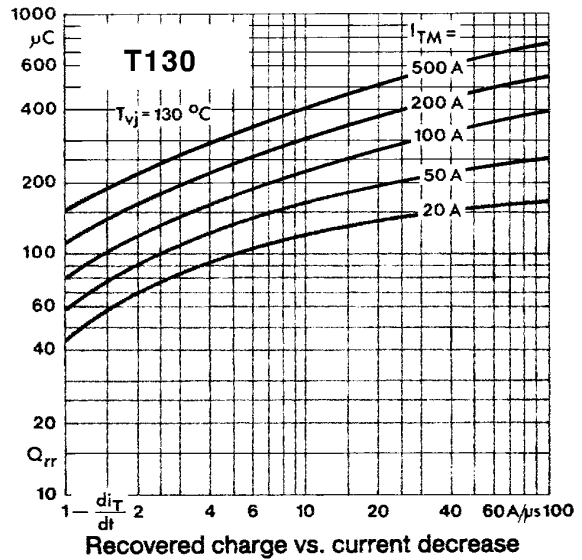
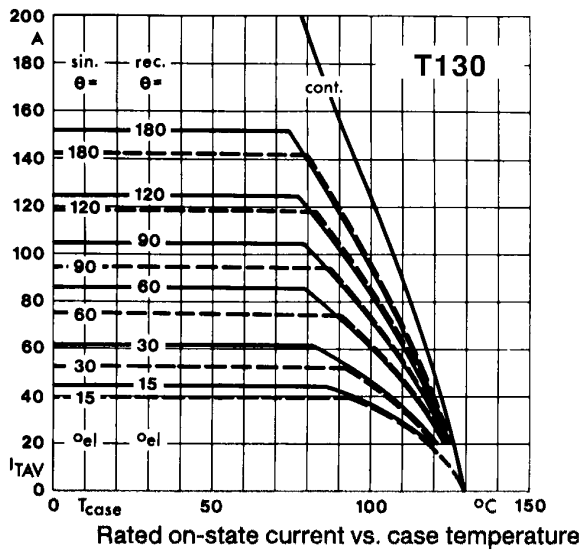
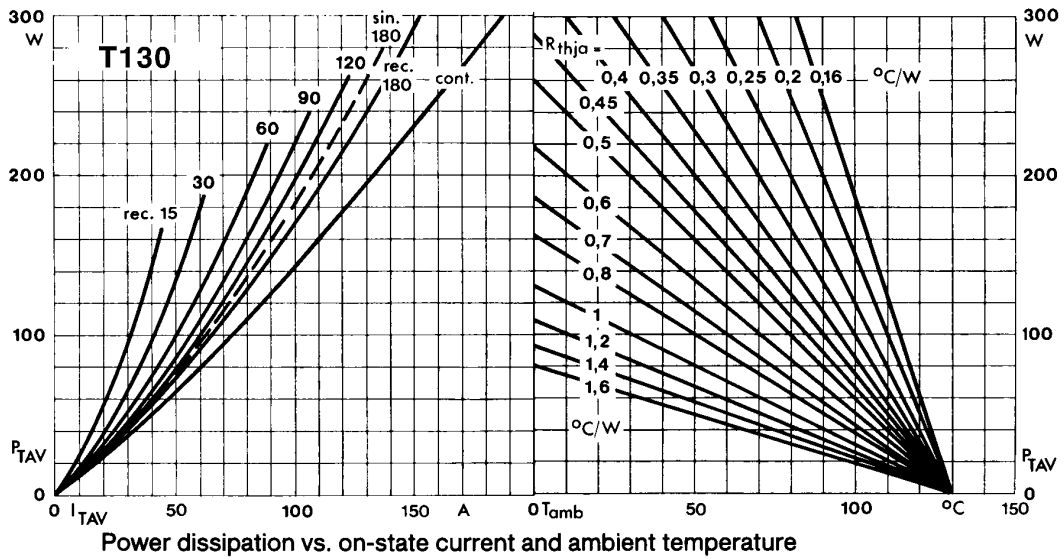

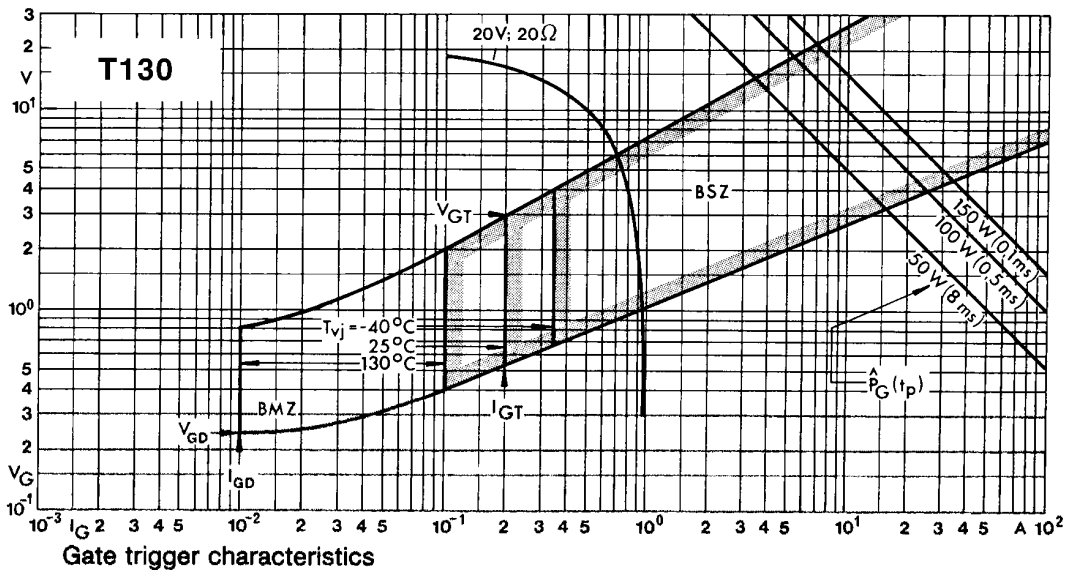
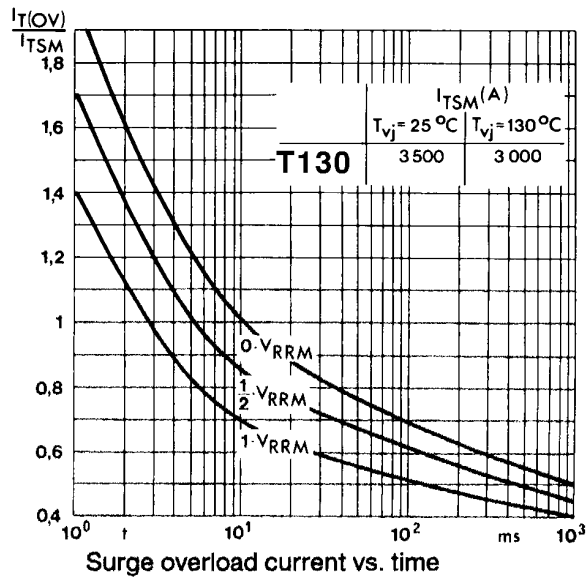
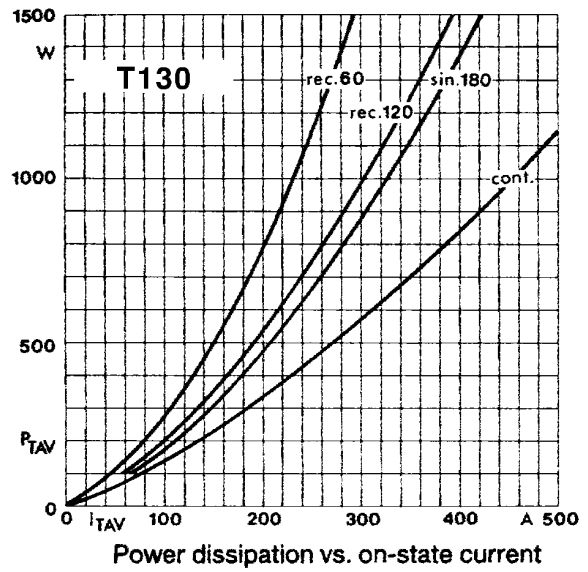
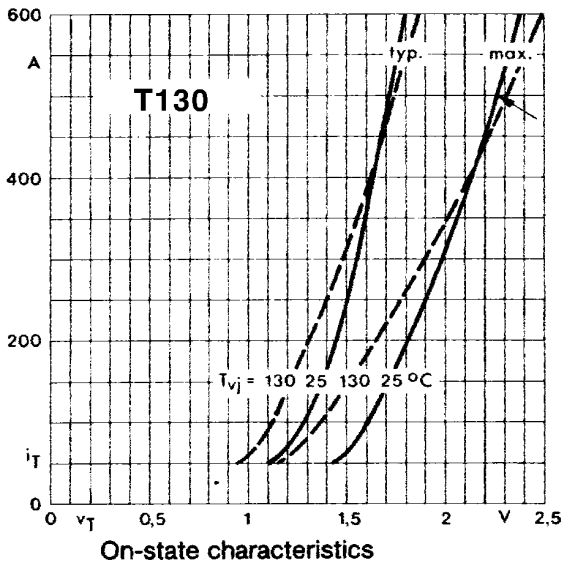

PACAKAGE DEATILS

DO NOT SCALE

All Dimensions in mm

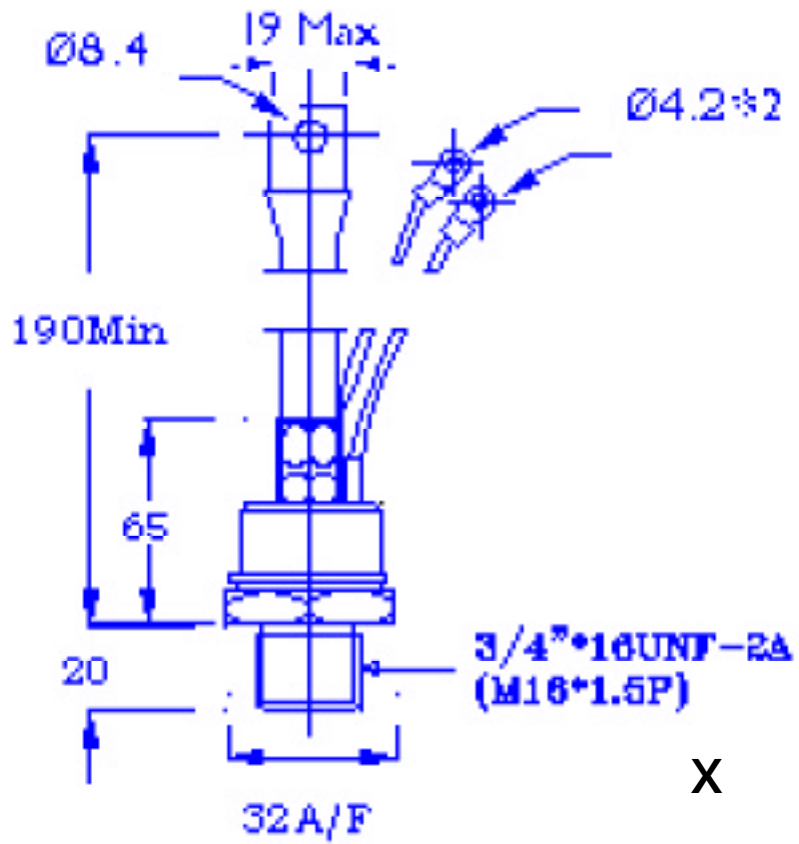

Mounting Torque : 30 NM