

Rectifier Diode

DS1107



Technical Data

Typical applications :All purpose high power rectifier diodes, Non-controllable and half controlled rectifiers . Free-wheeling diodes & traction.

Type No.	V_{RRM} (Volts)	V_{RSM} (Volts)
DS1107/24	2400	2500
DS1107/30	3000	3100
DS1107/32	3200	3300
DS1107/36	3600	3700
DS1107/43	4300	4400

Features

- Reverse voltage upto 4300V
- Double side cooling.
- High surge capability.

Symbol	Conditions	Values
$I_{F(AV)}$	Sin 180 ; Tcase = 100 °C	870 A
I_{FSM}	Tvj = 150 °C ; 10 ms, $V_{RRM} = 50\%$	12 KA
	Tvj = 150 °C ; 10 ms, $V_{RRM} = 0$	15 KA
I^2t	Tvj = 150 °C, $V_{RRM} = 50\%$	720000 A ² s
	Tvj = 150 °C, $V_{RRM} = 0$	1125000 A ² s
I_{RRM}	Tvj = 150 °C	50 mA max
V_F	Tvj = 25 °C ; $I_F = 1800 A$	1.60 V max
V_0	Tvj = 150 °C	0.75 V
R_0	Tvj = 150 °C	0.44 m
$R_{th(j-c)}$		0.032 °C/W
$R_{th(c-h)}$		0.008 °C/W
T_{vj}		150 °C
T_{stg}		-40.....+ 175 °C
Mounting Force	SI units	12.5-15 KN
Weight	Approx	310 g
Case outline		G



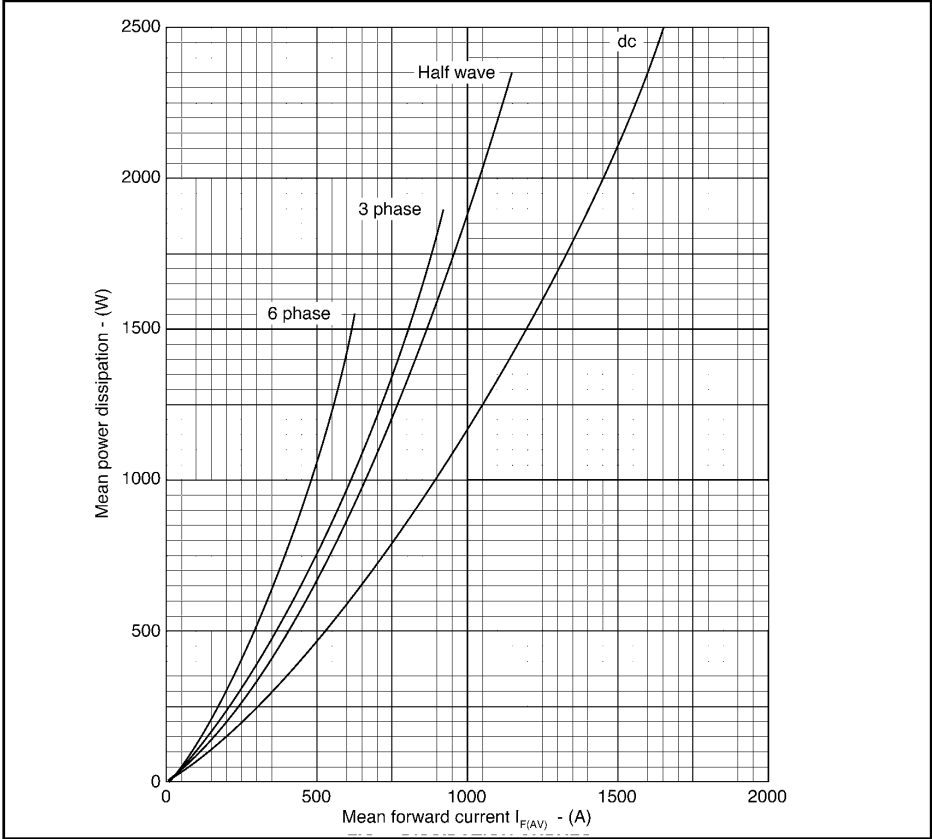

Dissipation curves

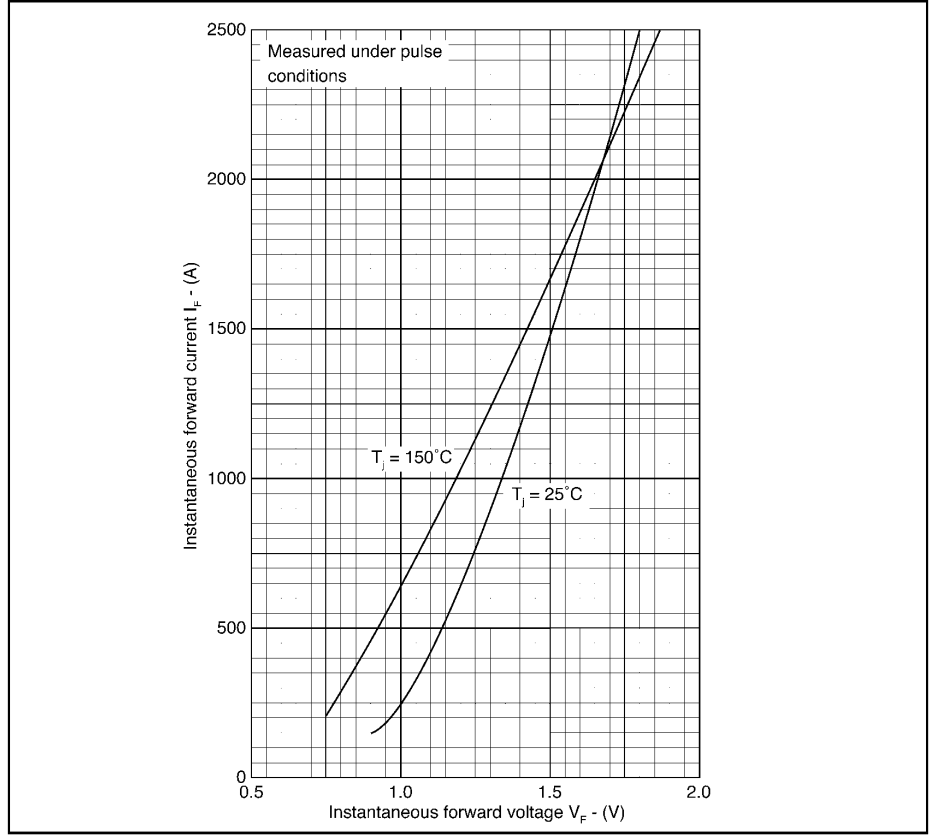

Maximum (limit) forward characteristics

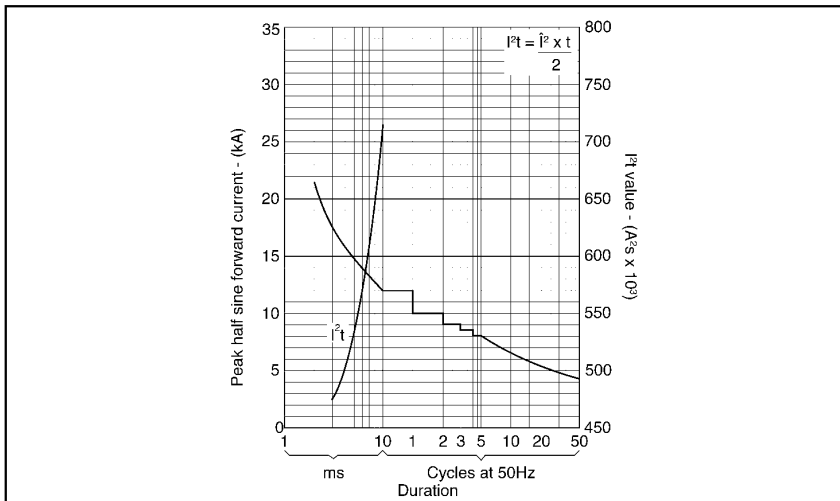

Surge (non-repetitive) forward current vs time (with 50% V_{RRM} , $T_{case} = 150^{\circ}C$)

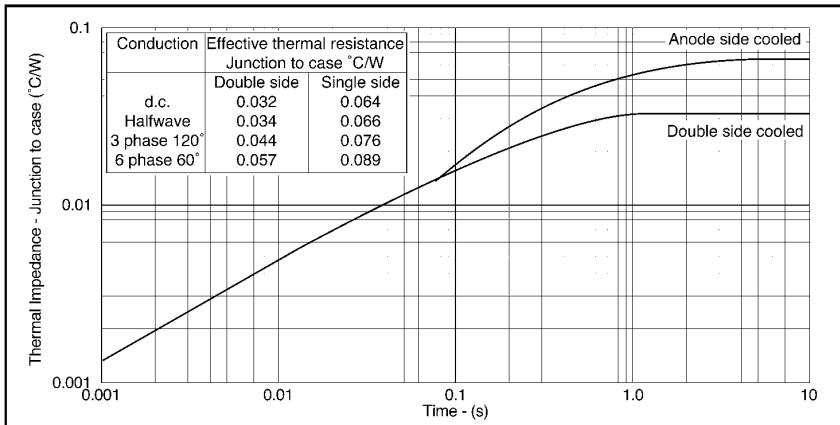

Transient thermal impedance - junction to case - (°C/W)

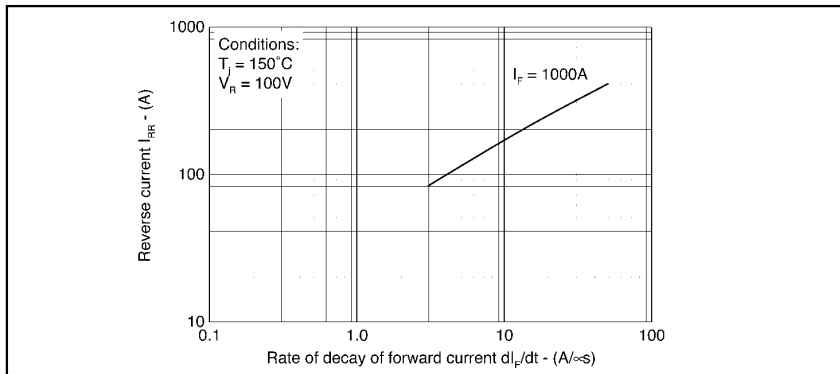

Maximum reverse recovery current

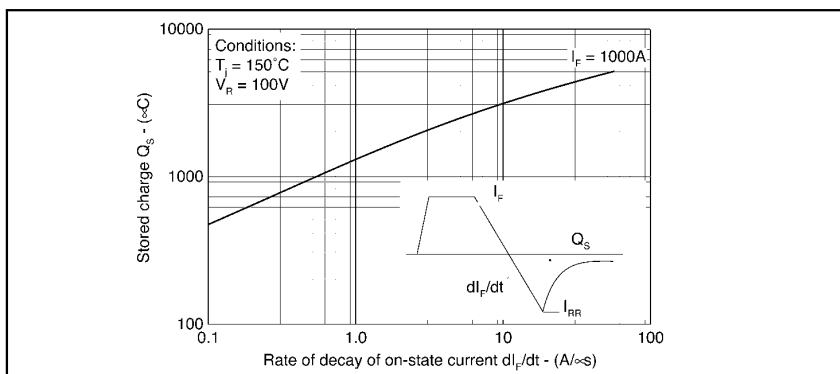

Maximum total stored charge

PACAKAGE DEATILS

DO NOT SCALE

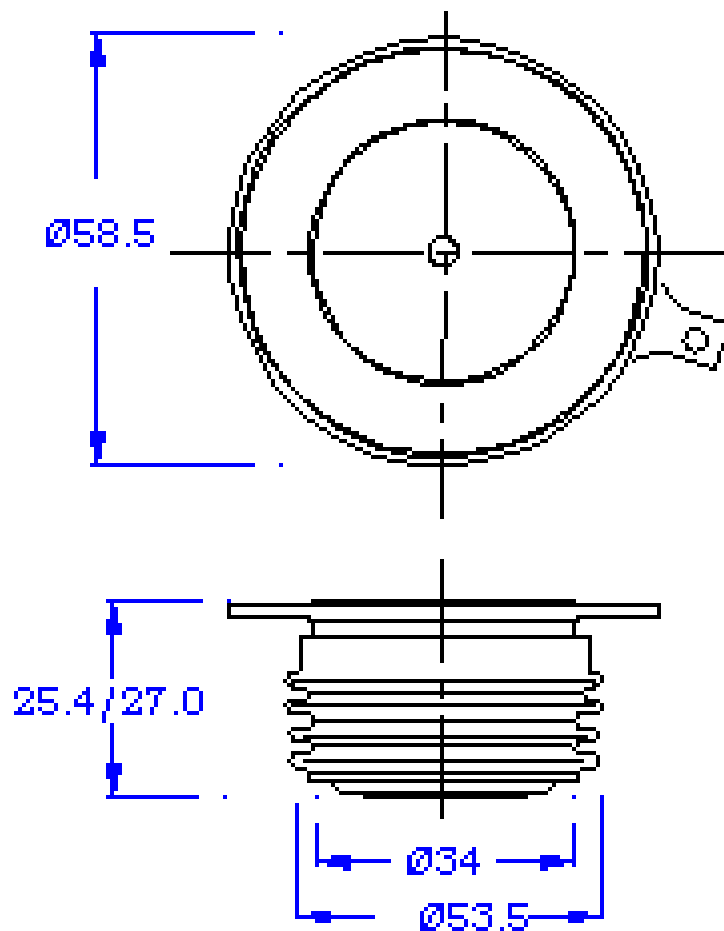

Nominal Weight : 310g
Clamping Force : 12.5-15KN

All Dimensions in mm

Package Outline : G