

Rectifier Diode

DS2007



Technical Data

Typical applications :All purpose high power rectifier diodes, Non-controllable and half controlled rectifiers, Free-wheeling diodes & traction (Railway Approved).

Type No.	V_{RRM} (Volts)	V_{RSM} (Volts)
DS2007/24	2400	2500
DS2007/30	3000	3100
DS2007/32	3200	3300
DS2007/36	3600	3700
DS2007/40	4000	4100

Features

- Reverse voltage upto 4000V.
- Double side cooling.
- High surge capability.

Symbol	Conditions	Values
$I_{F(AV)}$	Sin 180 ; Tcase = 100 °C	1225 A
I_{FSM}	Tvj = 150 °C ; 10 ms, $V_{RRM} = 50\%$	20 KA
	Tvj = 150 °C ; 10 ms, $V_{RRM} = 0$	25 KA
I^2t	Tvj = 150 °C, $V_{RRM} = 50\%$	2000000 A ² s
	Tvj = 150 °C, $V_{RRM} = 0$	3125000 A ² s
I_{RRM}	Tvj = 150 °C	75 mA max
V_F	Tvj = 25 °C ; $I_F = 3400 A$	1.60 V max
V_0	Tvj = 150 °C	0.82 V
R_0	Tvj = 150 °C	0.29 m
$R_{th(j-c)}$		0.022 °C/W
$R_{th(c-h)}$		0.004 °C/W
T_{vj}		150 °C
T_{stg}		-40.....+ 175 °C
Mounting Force	SI units	20-22 KN
Weight	Approx	500 g
Case outline		F



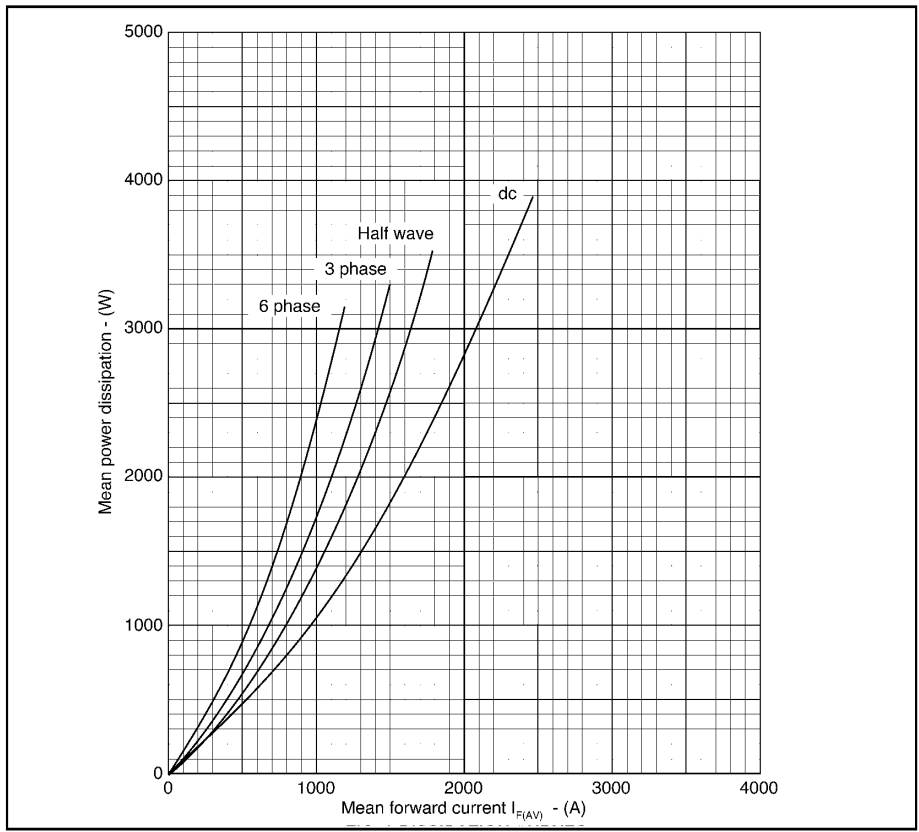

Dissipation curves

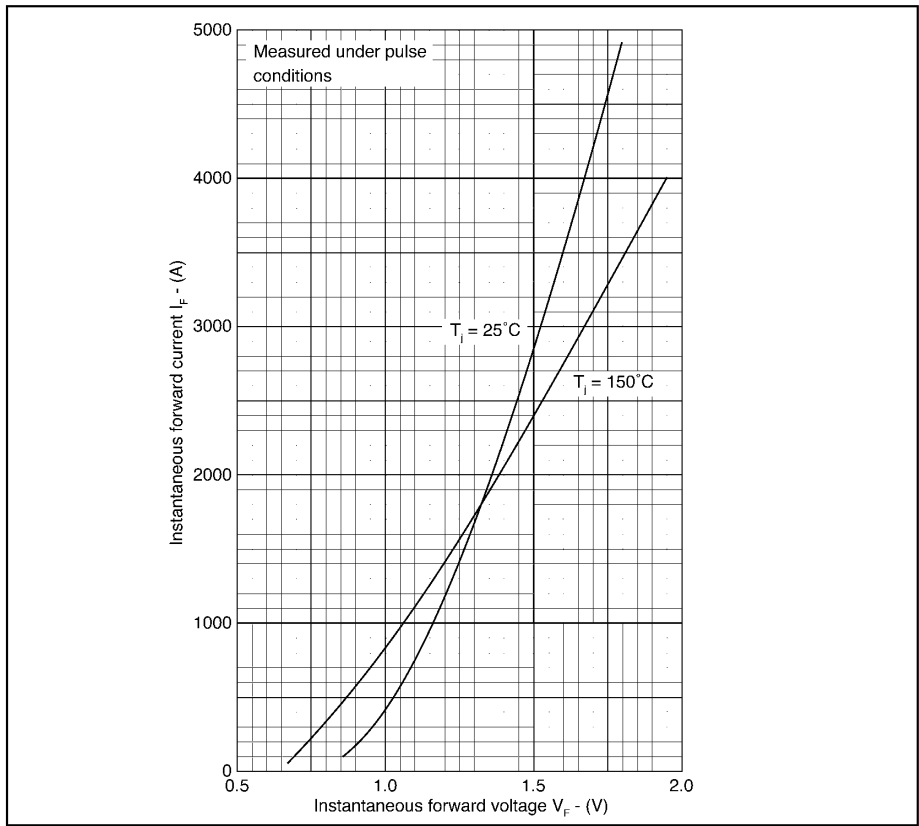

Maximum (limit) forward characteristics

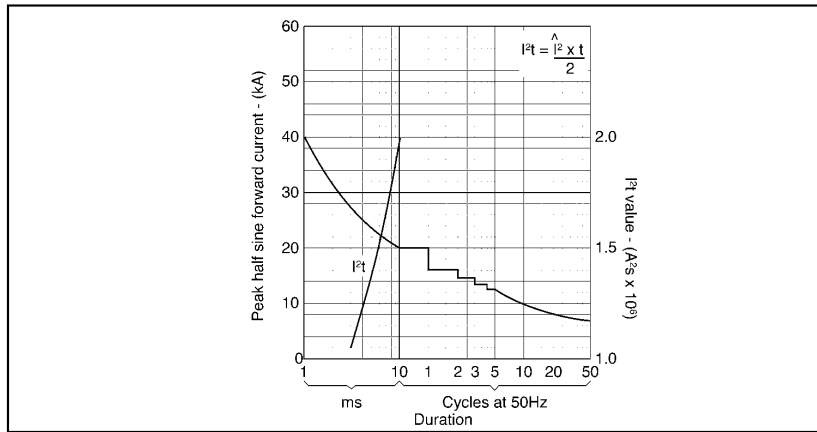

Surge (non-repetitive) forward current vs time (with 50% V_{RRM} , $T_{case} = 150^\circ\text{C}$)

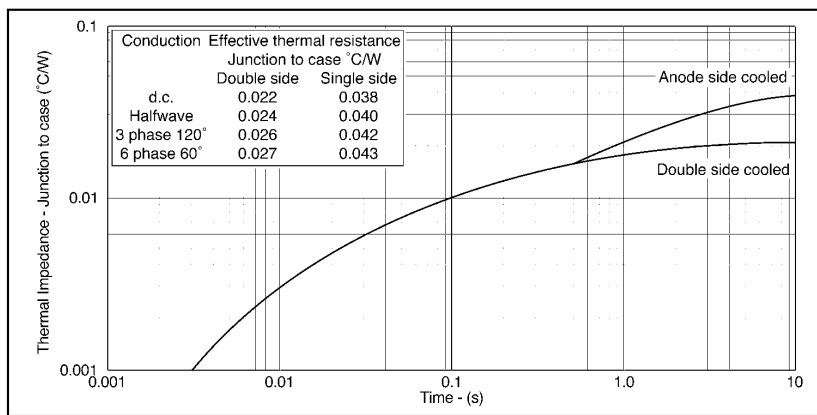

Transient thermal impedance - junction to case - ($^\circ\text{C/W}$)

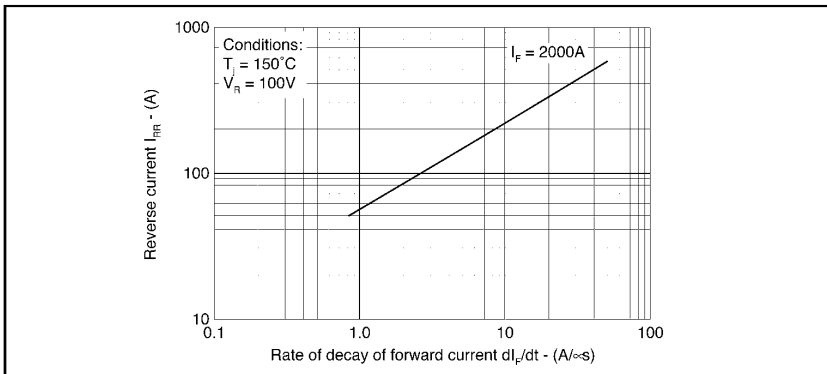

Maximum reverse recovery current

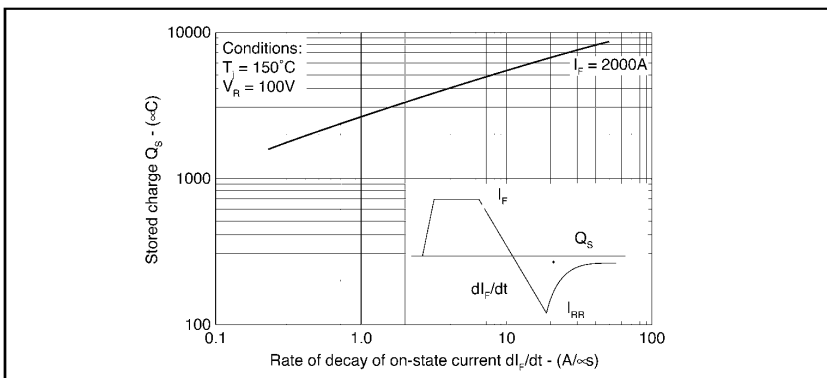

Maximum total stored charge

PACAKAGE DEATILS

DO NOT SCALE

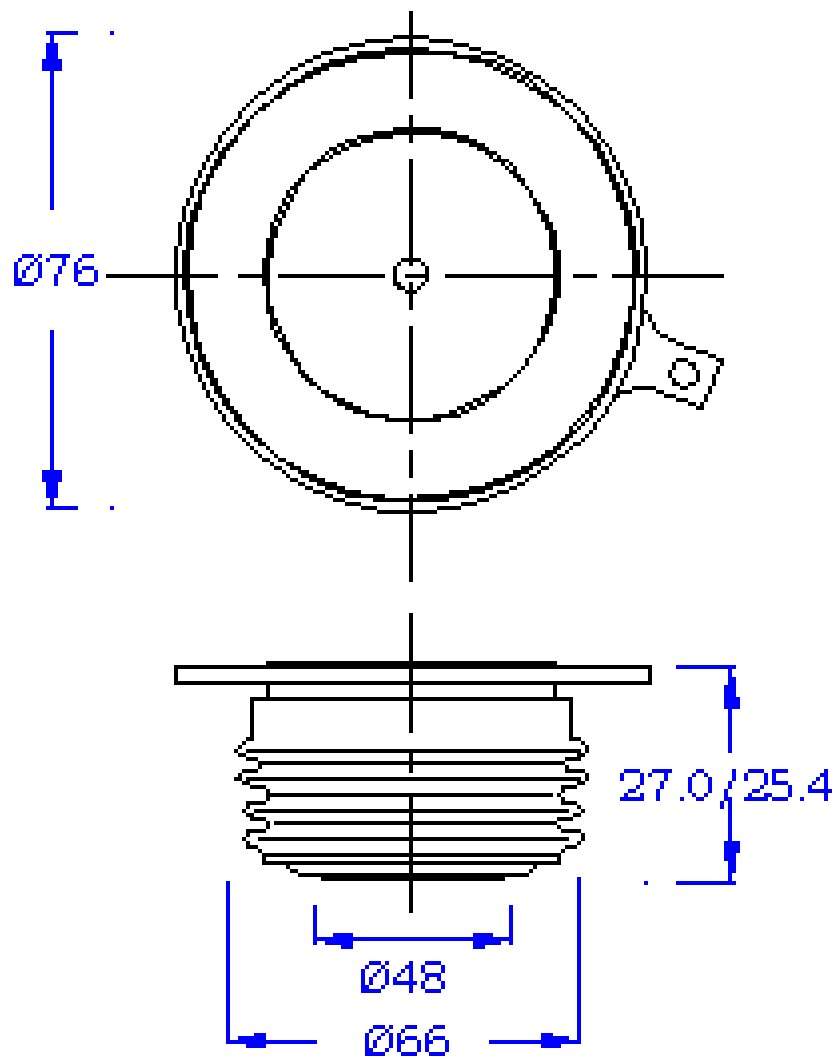

Nominal Weight : 500g
Clamping Force : 20-22KN

All Dimensions in mm

Package Outline : F