



32K × 8 HIGH SPEED CMOS STATIC RAM

GENERAL DESCRIPTION

The W24257AJ-8N is a high speed, low power CMOS static RAM organized as 32768 × 8 bits that operates on a single 5-volt power supply. This device is manufactured using Winbond's high performance CMOS technology.

FEATURES

- High speed access time: 8 nS (max.)
- Single +5V power supply
- Fully static operation
- All inputs and outputs directly TTL compatible
- Three-state outputs
- Available packages: 28-pin 300 mil SOJ

PIN CONFIGURATIONS

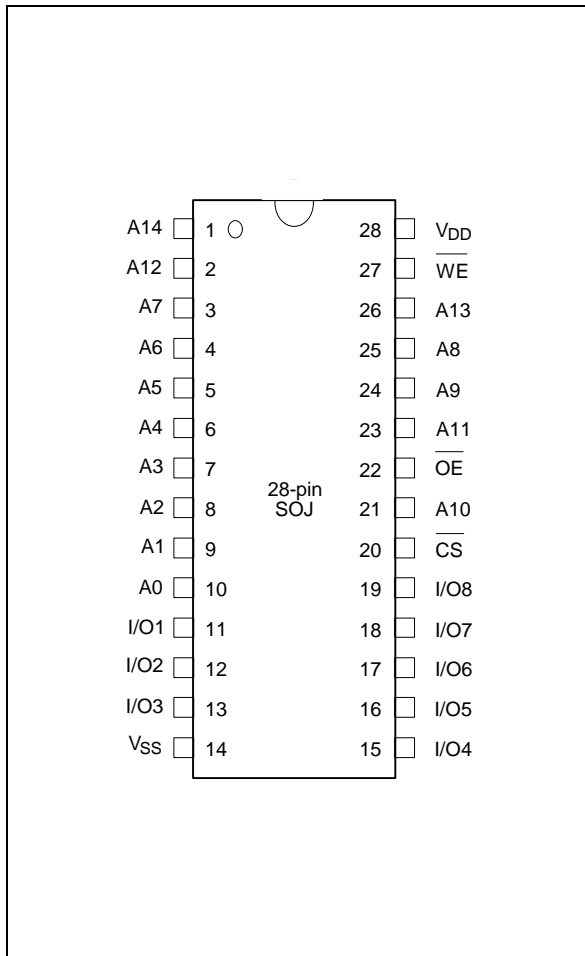

BLOCK DIAGRAM

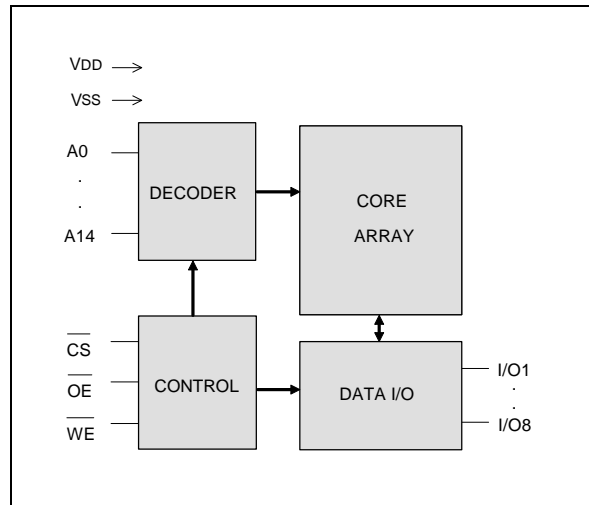

PIN DESCRIPTION

SYMBOL	DESCRIPTION
A0–A14	Address Inputs
I/O1–I/O8	Data Inputs/Outputs
\overline{CS}	Chip Select Input
\overline{WE}	Write Enable Input
\overline{OE}	Output Enable Input
VDD	Power Supply
VSS	Ground



DC CHARACTERISTICS

Absolute Maximum Ratings

PARAMETER	RATING	UNIT
Supply Voltage to Vss Potential	-0.5 to +7.0	V
Input/Output to Vss Potential	-0.5 to VDD +0.5	V
Allowable Power Dissipation	1.0	W
Storage Temperature	-65 to +150	°C
Operating Temperature	0 to +55	°C

Note: Exposure to conditions beyond those listed under Absolute Maximum Ratings may adversely affect the life and reliability of the device.

TRUTH TABLE

$\overline{\text{CS}}$	$\overline{\text{OE}}$	$\overline{\text{WE}}$	MODE	I/O1-I/O8	VDD CURRENT
H	X	X	Not Selected	High Z	ISB, ISB1
L	H	H	Output Disable	High Z	IDD
L	L	H	Read	Data Out	IDD
L	X	L	Write	Data In	IDD

OPERATING CHARACTERISTICS

(VDD = 5V ±5%, VSS = 0V, TA = 0 to 55° C)

PARAMETER	SYM.	TEST CONDITIONS	MIN.	TYP.	MAX.	UNIT
Input Low Voltage	VIL	-	-0.5	-	+0.8	V
Input High Voltage	VIH	-	+2.2	-	VDD +0.5	V
Input Leakage Current	ILI	VIN = VSS to VDD	-10	-	+10	μA
Output Leakage Current	ILO	V _{I/O} = VSS to VDD, $\overline{\text{CS}}$ = VIH or $\overline{\text{OE}}$ = VIH or $\overline{\text{WE}}$ = VIL	-10	-	+10	μA
Output Low Voltage	VOL	IOL = +8.0 mA	-	-	0.4	V
Output High Voltage	VOH	IOH = -4.0 mA	2.4	-	-	V
Operating Power Supply Current	IDD	$\overline{\text{CS}}$ = VIL, I/O = 0 mA, Cycle = Min., Duty = 100%			180	mA
Standby Power Supply Current	ISB	$\overline{\text{CS}}$ = VIH, Cycle = Min., Duty = 100%	-	-	30	mA
	ISB1	$\overline{\text{CS}} \geq \text{VDD} - 0.2\text{V}$	-	-	10	mA

Note: Typical characteristics are at VDD = 5V, TA = 25° C.



CAPACITANCE

(VDD = 5V, TA = 25° C, f = 1 MHz)

PARAMETER	SYM.	CONDITIONS	MAX.	UNIT
Input Capacitance	C _{IN}	V _{IN} = 0V	8	pF
Input/Output Capacitance	C _{I/O}	V _{OUT} = 0V	10	pF

Note: These parameters are sampled but not 100% tested.

THERMAL RESISTANCE

PARAMETER	SYM.	CONDITIONS	MAX.	UNIT
Junction to Case Thermal Resistance	θ _{JC}	A. F. R. = 1m/sec, TA = 25° C	20	°C/W
Junction to Ambient Thermal Resistance	θ _{JA}	A. F. R. = 1m/sec, TA = 25° C	60	°C/W

Note: These parameters are only applied to "TSOP" and "SOJ" package types.

AC TEST CONDITIONS

PARAMETER	CONDITIONS
Input Pulse Levels	0V to 3V
Input Rise and Fall Times	5 nS
Input and Output Timing Reference Level	1.5V
Output Load	CL = 30 pF, I _{OH} /I _{OL} = -4 mA/8 mA

AC TEST LOADS AND WAVEFORM

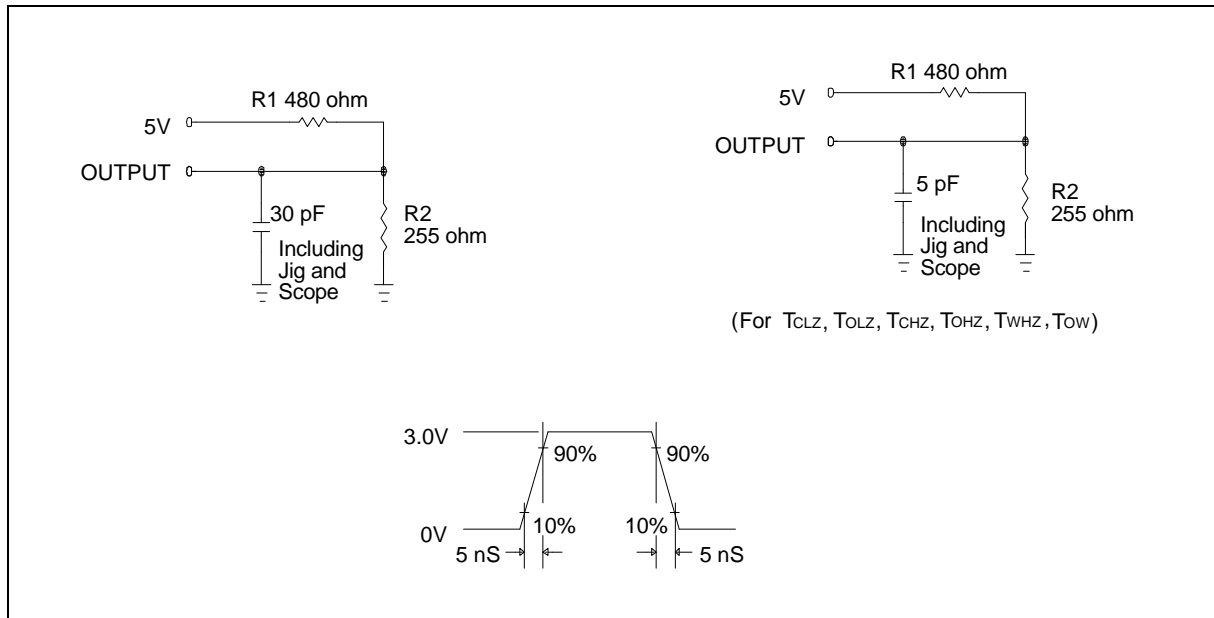



AC CHARACTERISTICS

(V_{DD} = 5V ±5%, V_{SS} = 0V, T_A = 0 to 55° C)

Read Cycle

PARAMETER	SYM.	W24257AJ-8N		UNIT
		MIN.	MAX.	
Read Cycle Time	TRC	8	-	nS
Address Access Time	TAA	-	8	nS
Chip Select Access Time	TACS	-	8	nS
Output Enable to Output Valid	TAOE	-	4	nS
Chip Selection to Output in Low Z	TCLZ*	3	-	nS
Output Enable to Output in Low Z	TOLZ*	0	-	nS
Chip Deselection to Output in High Z	TCHZ*	-	4	nS
Output Disable to Output in High Z	TOHZ*	-	4	nS
Output Hold from Address Change	TOH	3	-	nS

* These parameters are sampled but not 100% tested.

Write Cycle

PARAMETER		SYM.	W24257AJ-8N		UNIT
			MIN.	MAX.	
Write Cycle Time		TWC	8	-	nS
Chip Selection to End of Write		TCW	7	-	nS
Address Valid to End of Write		TAW	7	-	nS
Address Setup Time		TAS	0	-	nS
Write Pulse Width		TWP	7	-	nS
Write Recovery Time	\overline{CS} , \overline{WE}	TWR	0	-	nS
Data Valid to End of Write		TDW	6	-	nS
Data Hold from End of Write		TDH	0	-	nS
Write to Output in High Z		TWHZ*	-	5	nS
Output Disable to Output in High Z		TOHZ*	-	5	nS
Output Active from End of Write		TOW	0	-	nS

* These parameters are sampled but not 100% tested.



TIMING WAVEFORMS

Read Cycle 1

(Address Controlled)

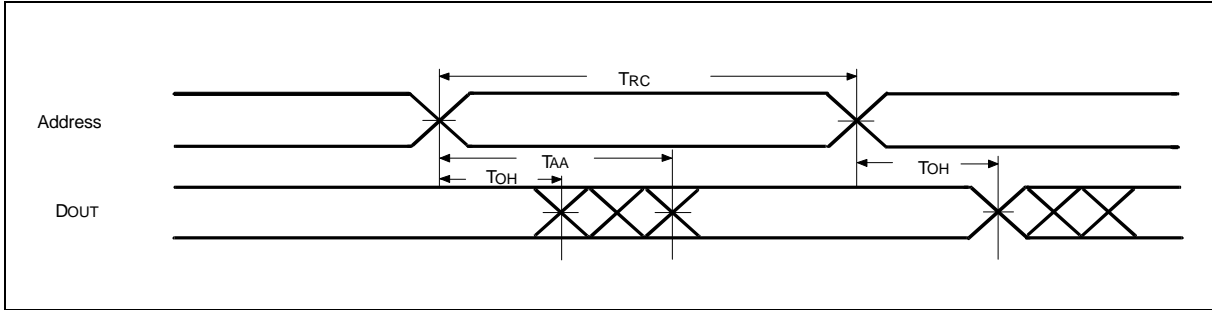

Read Cycle 2

(Chip Select Controlled)

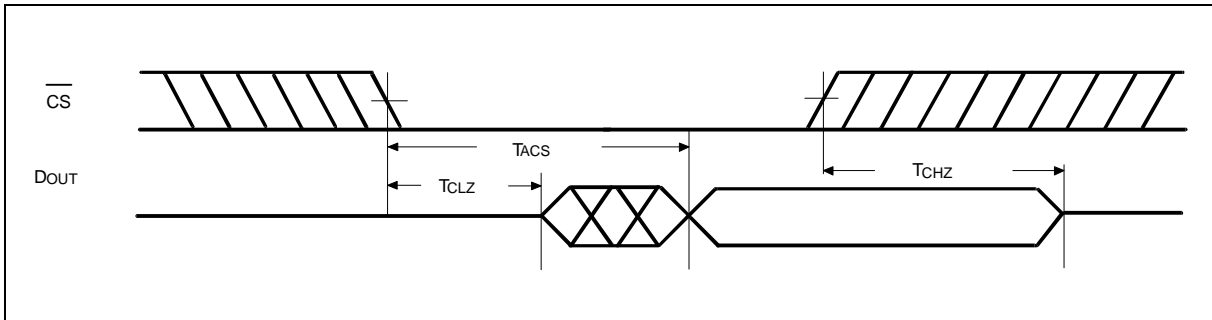

Read Cycle 3

(Output Enable Controlled)

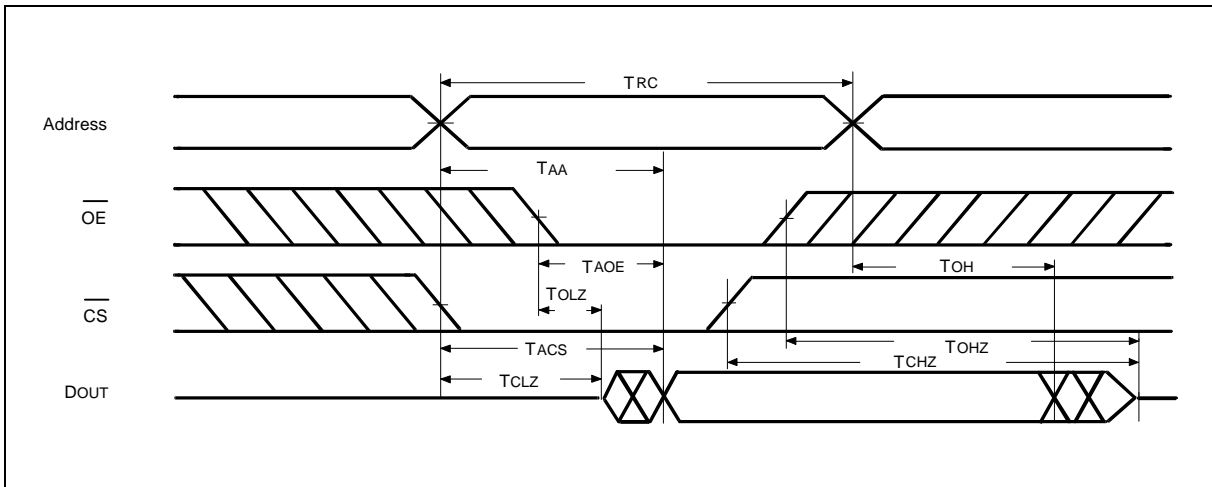



Timing Waveforms, continued

Write Cycle 1
(\overline{OE} Clock)

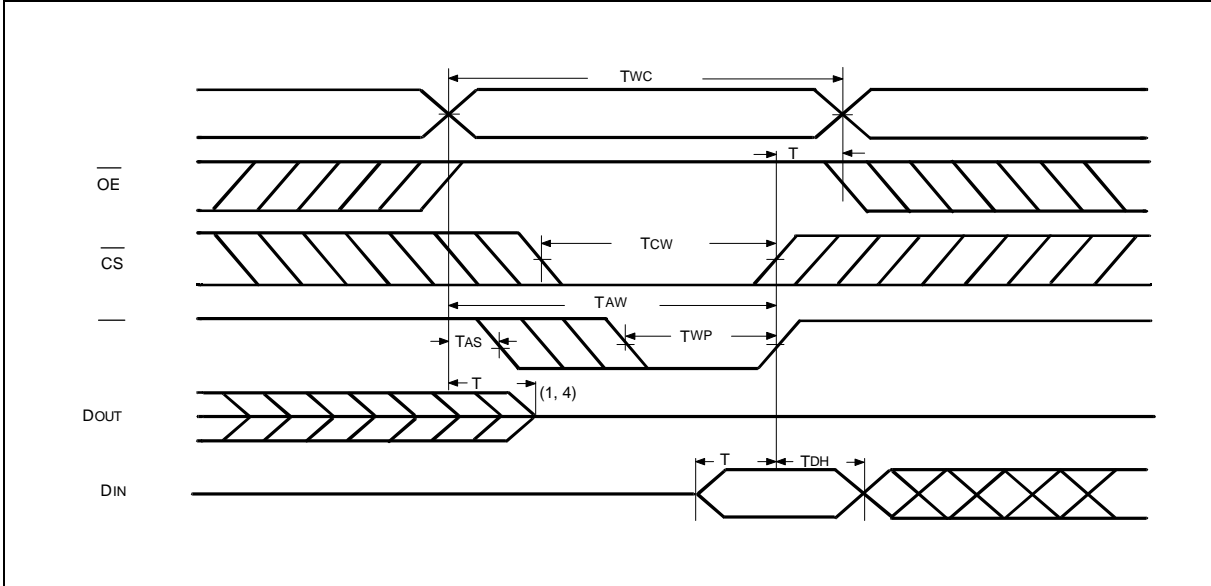

Write Cycle 2
($\overline{OE} = V_{IL}$ Fixed)

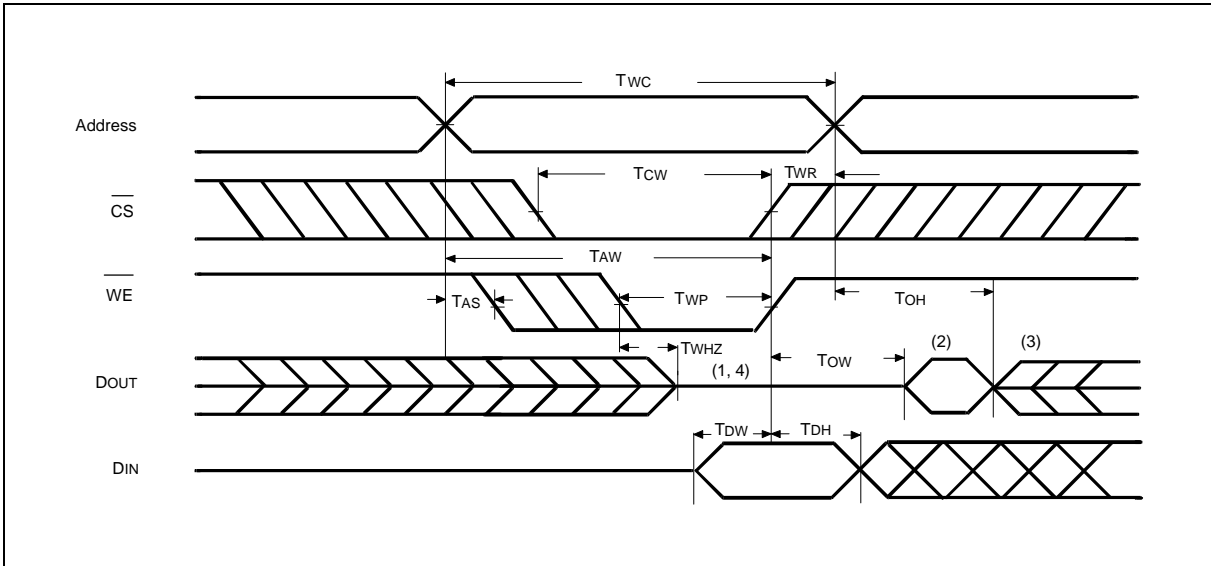

Notes:

1. During this period, I/O pins are in the output state, so input signals of opposite phase to the outputs should not be applied.
2. The data output from DOUT are the same as the data written to DIN during the write cycle.
3. DOUT provides the read data for the next address.
4. Transition is measured ± 500 mV from steady state with $C_L = 5$ pF. This parameter is guaranteed but not 100% tested.



ORDERING INFORMATION

PART NO.	ACCESS TIME (nS)	OPERATING CURRENT MAX. (mA)	STANDBY CURRENT MAX. (mA)	PACKAGE
W24257AJ-8N	8	180	10	300 mil SOJ

Notes:

1. Winbond reserves the right to make changes to its products without prior notice.
2. Purchasers are responsible for performing appropriate quality assurance testing on products intended for use in applications where personal injury might occur as a consequence of product failure.

PACKAGE DIMENSIONS

28-pin Small Outline J Band

Symbol	Dimension in Inches			Dimension in mm		
	Min.	Nom.	Max.	Min.	Nom.	Max.
A	—	—	0.140	—	—	3.56
A ₁	0.027	—	—	0.69	—	—
A ₂	0.095	0.100	0.105	2.41	2.54	2.67
b ₁	0.026	0.028	0.032	0.66	0.71	0.81
b	0.016	0.018	0.022	0.41	0.46	0.56
c	0.008	0.010	0.014	0.20	0.25	0.36
D	—	0.710	0.730	—	18.03	18.54
E	0.295	0.300	0.305	7.49	7.62	7.75
e	0.044	0.050	0.056	1.12	1.27	1.42
e ₁	0.245	0.265	0.285	6.22	6.73	7.24
H _E	0.327	0.337	0.347	8.31	8.56	8.81
L	0.077	0.087	0.097	1.96	2.21	2.46
S	—	—	0.045	—	—	1.14
y	—	—	0.004	—	—	0.10
θ	0°	—	10°	0°	—	10°

Notes:

1. Dimensions D Max. & S include mold flash or tie bar burrs.
2. Dimension b does not include dambar protrusion/intrusion.
3. Dimensions D & E include mold mismatch and are determined at the mold parting line.
4. Controlling dimension: Inches.
5. General appearance spec. should be based on final visual inspection spec.



VERSION HISTORY

VERSION	DATE	PAGE	DESCRIPTION
A1	Nov. 1997		Initial Issued
A2	Feb. 1998	4	Modify TDW(Data Valid to End of Write) from 5 nS to 6 nS



Headquarters

No. 4, Creation Rd. III,
Science-Based Industrial Park,
Hsinchu, Taiwan
TEL: 886-3-5770066
FAX: 886-3-5796096
<http://www.winbond.com.tw/>
Voice & Fax-on-demand: 886-2-27197006

Taipei Office

11F, No. 115, Sec. 3, Min-Sheng East Rd.,
Taipei, Taiwan
TEL: 886-2-27190505
FAX: 886-2-27197502

Winbond Electronics (H.K.) Ltd.

Rm. 803, World Trade Square, Tower II,
123 Hoi Bun Rd., Kwun Tong,
Kowloon, Hong Kong
TEL: 852-27513100
FAX: 852-27552064

Winbond Electronics North America Corp.

Winbond Memory Lab.
Winbond Microelectronics Corp.
Winbond Systems Lab.
2727 N. First Street, San Jose,
CA 95134, U.S.A.
TEL: 408-9436666
FAX: 408-5441798

Note: All data and specifications are subject to change without notice.