



2SD1294

NPN SILICON DARLINGTON TRANSISTOR

**SWITCHING REGULATORS PWM INVERTERS
SOLENOID AND RELAY DRIVERS**

ABSOLUTE MAXIMUM RATINGS (T_A=25°C)

Characteristic	Symbol	Rating	Unit
Collector-Base Voltage	VCBO	60	V
Collector-Emitter Voltage	VCEO	60	V
Collector Current (DC)	Ic	5	A
Collector Dissipation (T _c =25°C)	Pc	80	W
Junction Temperature	T _j	150	°C
Storage Temperature	T _{stg}	-50~150	°C

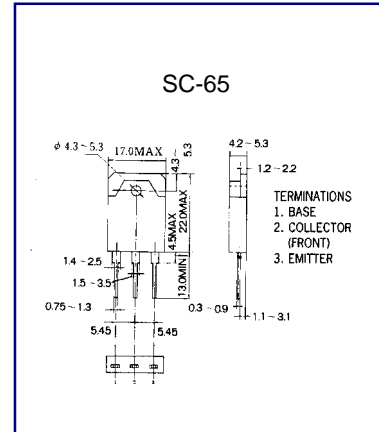

ELECTRICAL CHARACTERISTICS (T_A=25°C)

Characteristic	Symbol	Test Condition	Min	Typ	Max	Unit
Collector Cutoff Current	ICBO	V _{CB} = 60V , I _E =0			10	μA
Collector Cutoff Current	ICEO	V _{CB} = 60V , I _B =0			10	μA
DC Current Gain	hFE	V _{CE} = 5V , I _C =0.5A	2000		12000	
Collector- Emitter Saturation Voltage	V _{CE(sat)}	I _C =0.5A , I _B =0.001A			1.5	V