



AG101

High Dynamic Range Gain Block

Product Features

- 60 - 3000 MHz
- +32 dBm Output IP3
- 2.4 dB Noise Figure
- 14 dB Gain
- +15 dBm P1dB
- MTBF >1000 Years
- SOT-89 SMT Package
- Single Bias Supply (+3.3 V or +4.5 V)



Actual Size

Product Description

The AG101 is a general purpose gain block that offers good dynamic range in a low cost surface mount package. The combination of flat OIP3 and noise figure performance over frequency makes it attractive for both narrow band and broadband applications. Superior thermal design allows the product to achieve +32 dBm OIP3 performance at a mounting temperature of +85°C with an associated MTBF of >1000 years³. All devices are 100% RF and DC tested.

Functional Diagram

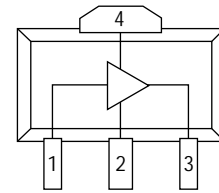

Function	Pin No.
Input	1
Ground	2
Output/Bias	3
Ground	4

Specifications

Parameter	Units	Min.	Typical	Max.
Frequency Range	MHz		60-3000	
S21 - Gain	dB	13.0	14.0	16.0
S11 - Input Return Loss	dB		-9.0	
S22 - Output Return Loss	dB		-15.0	
Output IP3	dBm	+28	+32	+36
Output P1dB	dBm		+15	
Noise Figure	dB		2.4	
Operating Current Range	mA	40	50	75
Supply Voltage	V		4.5	

Test conditions unless otherwise noted.
 1. T = 25°C, Vdd = 4.5 V, Frequency = 800 MHz, 50 ohm system.
 2. 3OIP measured with two tones at an output power of 2 dBm/tone separated by 10 MHz. The suppression on the largest IM3 product is used to calculate the 3OIP using a 2:1 slope rule.
 3. MTBF calculated with ground lead temperature at 85°C.
 4. S11 can be improved using an optional matching network.

Recommended Maximum Ratings

Parameter	Rating
Operating Case Temperature	-40 to +85°C
Storage Temperature	-55 to +125°C
DC Voltage	+5.5 V
RF Input Power (continuous)	+4 dBm

Operation of this device above any of these parameters may cause permanent damage.

Typical Parameters

Parameter	Units	Typical	
Frequency	MHz	900	1900
S21	dB	13.4	12.2
S11	dB	-12.5	-13.2
S22	dB	-21.2	-17.8
Output IP3	dBm	+32.5	+33.1
Output P1dB	dBm	+15.1	+15.0
Noise Figure	dB	2.4	2.6

Typical parameters reflect performance in an applicaton circuit.

Ordering Information

Part No.	Description
AG101	GaAs MMIC Amplifier (Available in tape and reel)
AG101-PCB	Fully Assembled Application Circuit

AG101

Advanced Product Information

Performance Charts (Vd = 4.5 V, Id = 50 mA, T = 25°C)

Gain vs. Frequency

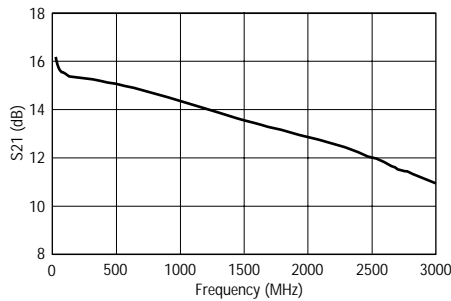

Return Loss vs. Frequency

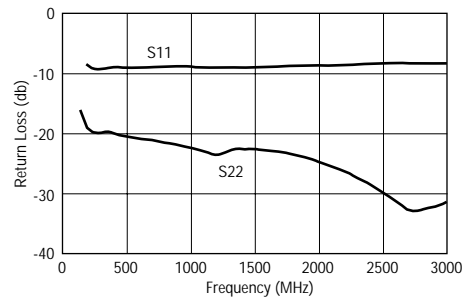

NF vs. Frequency

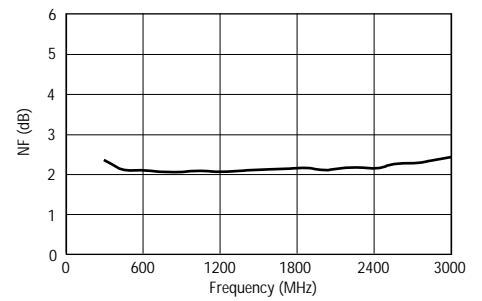

OIP3 vs. Frequency

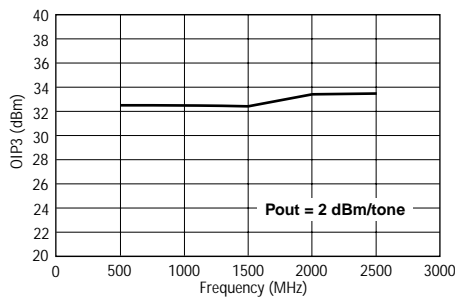

OIP3 vs. Pout

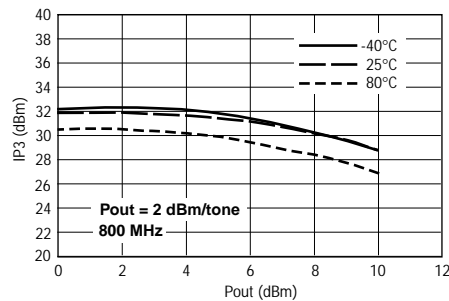

OIP3 vs. Pout

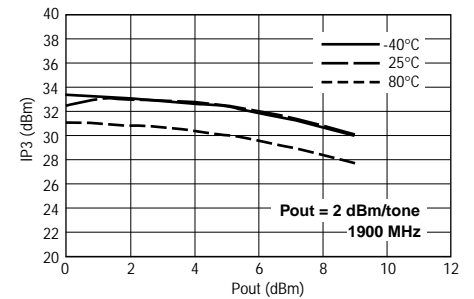

S21 vs. Frequency over Temperature

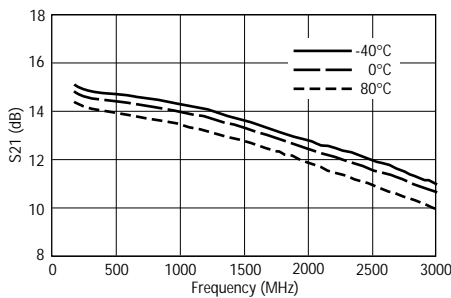

S11 vs. Frequency over Temperature

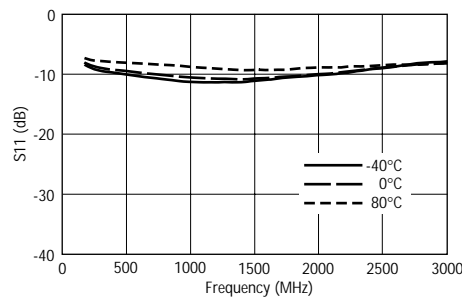

S22 vs. Frequency over Temperature

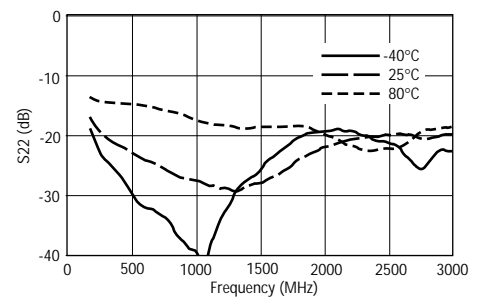

Gain vs. Pout

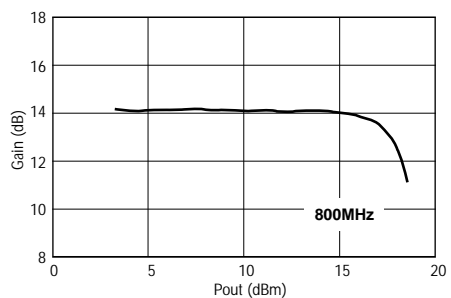

Performance Charts (Vd = 3.3 V, Id = 50 mA, T = 25°C)

Gain vs. Frequency

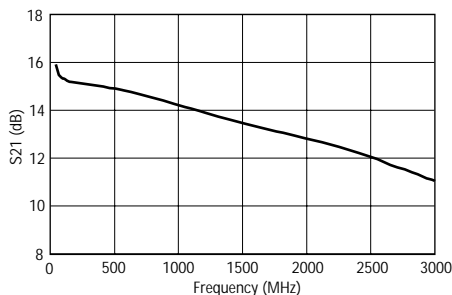

Return Loss vs. Frequency

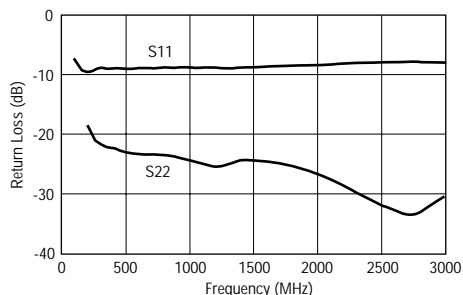

NF vs. Frequency

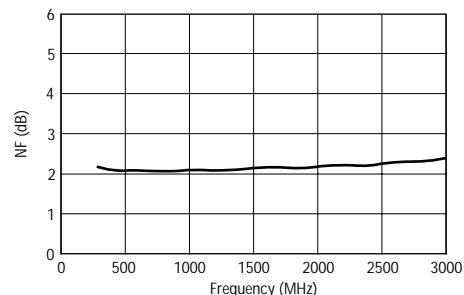

OIP3 vs. Frequency

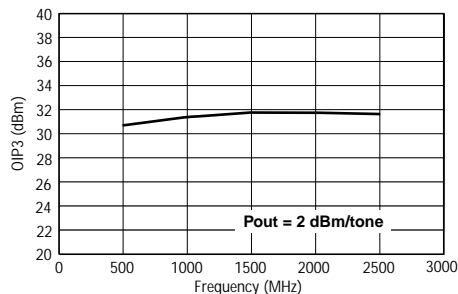

OIP3 vs. Pout over Temperature

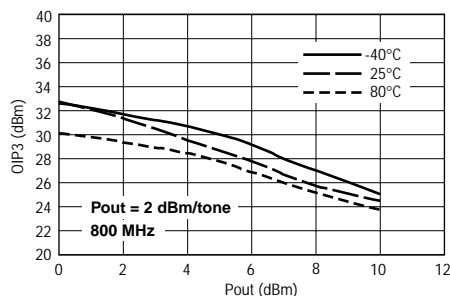

OIP3 vs. Pout over Temperature

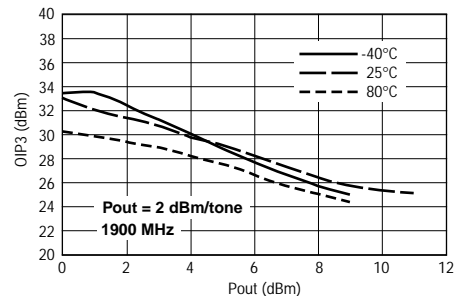

S21 vs. Frequency over Temperature

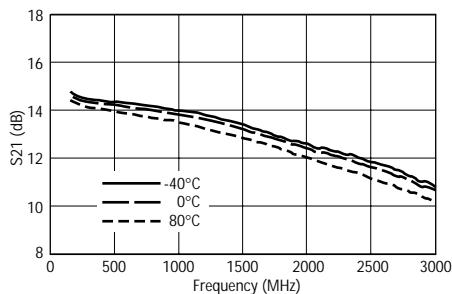

S11 vs. Frequency over Temperature

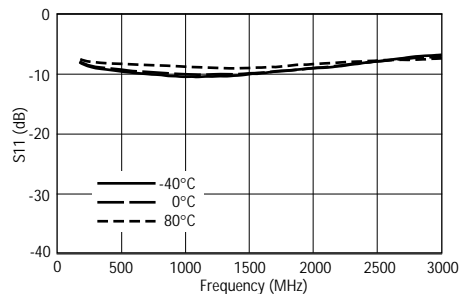

S22 vs. Frequency over Temperature

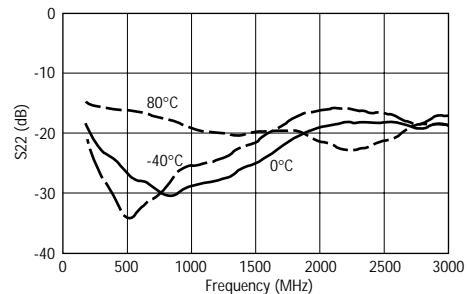

Gain vs. Pout

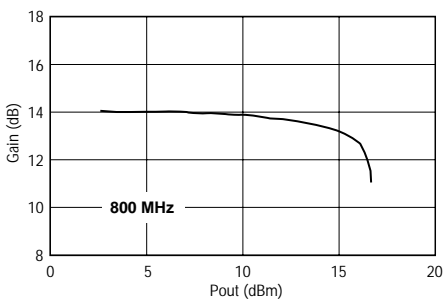

Application Circuit: 0.8 to 2.6 GHz

Typical Specifications

Frequency	0.9 GHz	1.9 GHz	2.4 GHz
Magnitude S21	13.4 dB	12.2 dB	11.5 dB
Magnitude S11	-12.5 dB	-13.2 dB	-11.4 dB
Magnitude S22	-21.2 dB	-17.8 dB	-17.3 dB
OIP3	32.5 dBm	33.1 dBm	33.1 dBm
Noise Figure	2.4 dB	2.6 dB	2.8 dBm
Bias	Vds = 4.5 V, Id = 50 mA		

Schematic

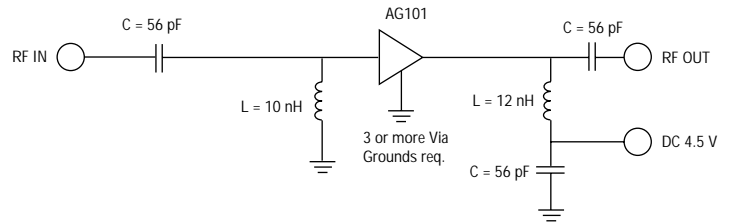

S-Parameters

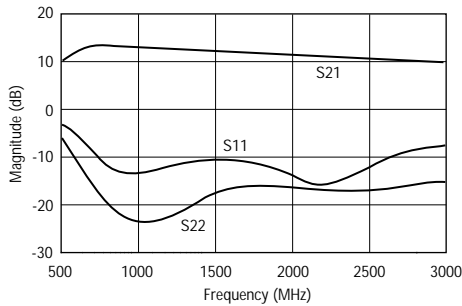

FR4 Board Layout (T = 14 Mils)

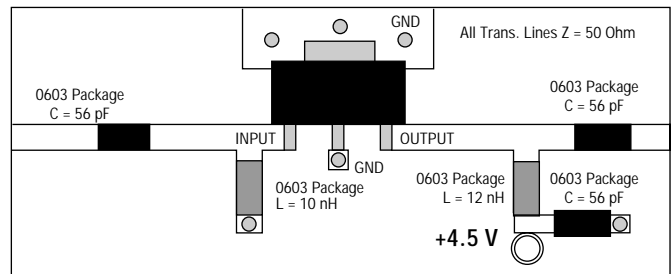

NOTE: The application circuit is designed for wide bandwidth. For narrow band applications, S11 and S21 can be improved with an input shunt microstrip element to ground.

Thermal Specifications

Parameter	Rating
Operating Case Temperature	-40 to +85°C
Thermal Resistance (Maximum)	88°C/W
Junction Temperature (Recommended Maximum)	+155°C

Notes:

1. Thermal Resistance determined at Maximum Tab Temperature and Maximum Power Dissipation.
2. Recommended Maximum Junction Temperature insures a MTBF of 1 million hours.
3. Refer to WJ Application Note "AG101 Temperature Effects on Reliability" for more information.

MTBF vs. Temperature

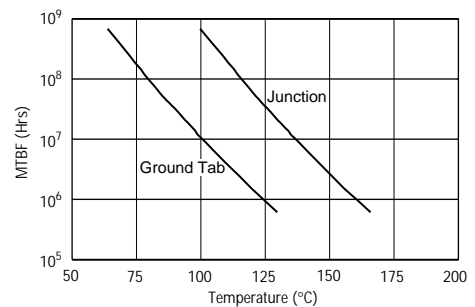

Application Circuit: 60 - 100 MHz

Typical Specifications

Frequency	70 MHz
Magnitude S21	16.3 dB
Magnitude S11	-17.1 dB
Magnitude S22	-15.6 dB
Noise Figure	5.1 dB
Bias Supply	4.5 V @ 50 mA

Schematic

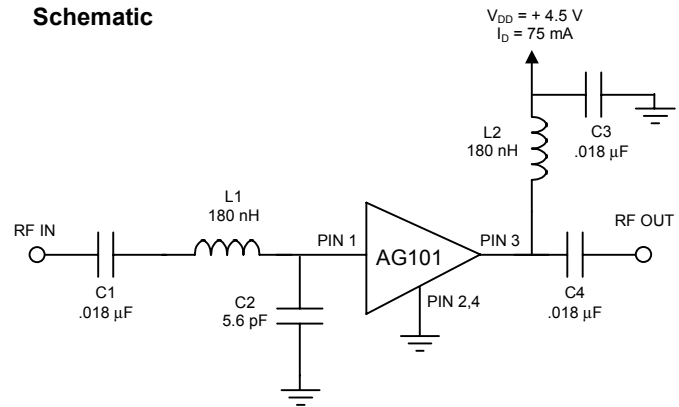

S-Parameters

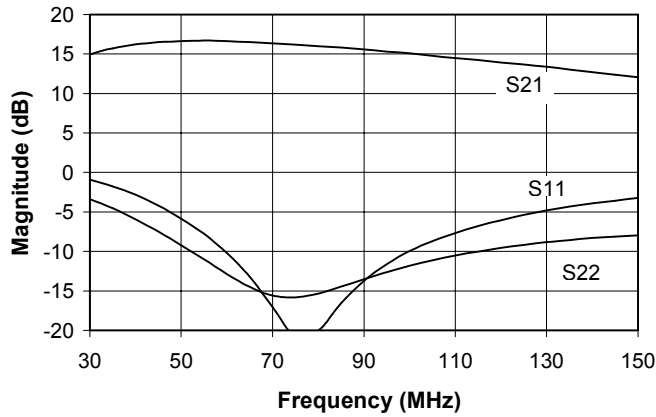

Noise Figure

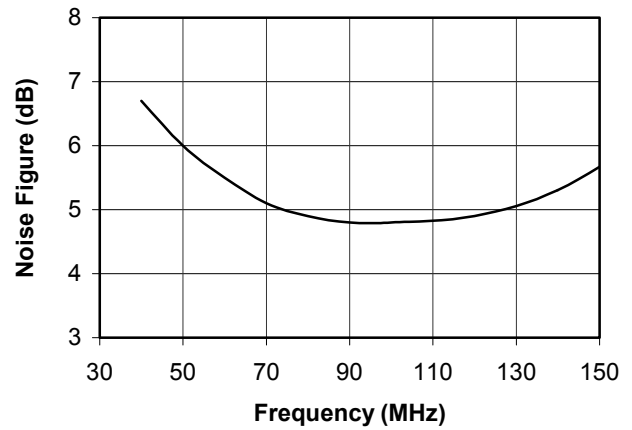

Outline Drawing

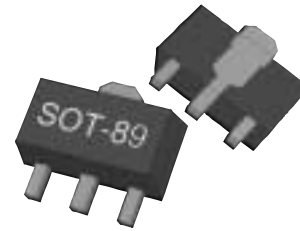
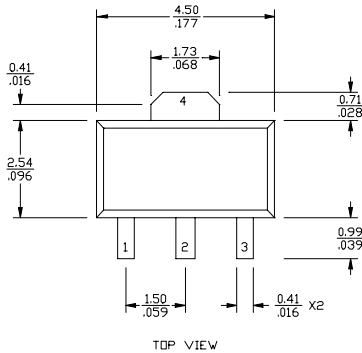

mm
inch

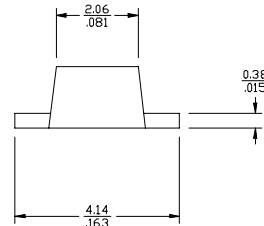
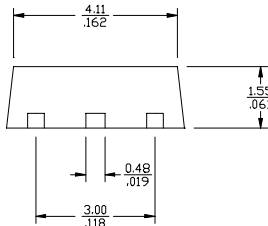

Land Pattern

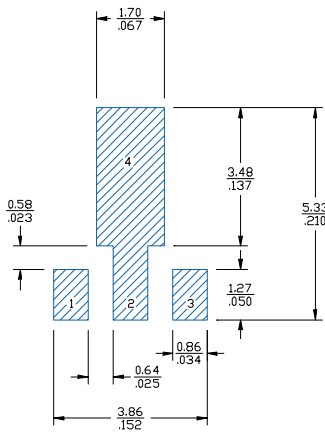

Mounting Configuration

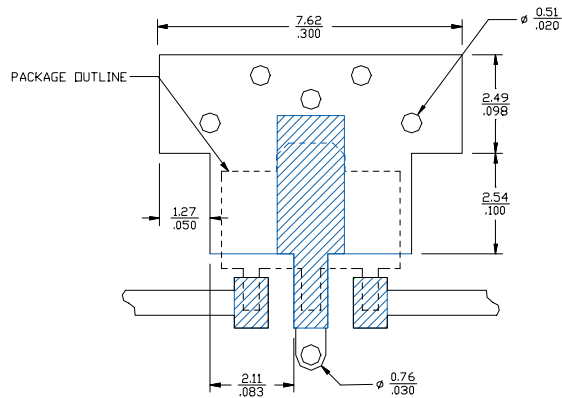

FUNCTION	PIN NO.
INPUT	1
GROUND	2
OUTPUT (BIAS)	3
GROUND	4

- Notes:
1. Ground vias are critical for thermal and RF grounding considerations.
 2. A minimum of 6 ground vias are required for 14 mil and 28 mil FR4 board.
 3. If your PCB design rules allow, ground vias should be placed under the land pattern for better RF and thermal performance. Otherwise ground vias should be placed as close to land pattern as possible.
 4. Trace width depends on PC board.



Typical Test Data

S-Parameters (V_{ds} = 3.3 V, I_{ds} = 50 mA, T = 25°C, unmatched device in a 50 ohm system)

Freq (GHz)	S11 (Mag)	S11 (Ang)	S21 (Mag)	S21 (Ang)	S12 (Mag)	S12 (Ang)	S22 (Mag)	S22 (Ang)
0.05	0.504	-31.0	5.90	165.0	0.0804	24.90	0.2170	-56.40
0.10	0.406	-27.4	5.52	167.0	0.0854	14.90	0.1210	-63.70
0.20	0.353	-24.8	5.25	166.0	0.0881	7.15	0.0712	-63.30
0.40	0.377	-29.5	5.05	159.0	0.0891	2.79	0.0780	-60.00
0.60	0.375	-40.5	4.91	151.0	0.0895	1.00	0.0719	-54.80
0.80	0.366	-51.9	4.80	142.0	0.0910	-0.71	0.0691	-50.00
1.00	0.358	-63.1	4.68	134.0	0.0926	-2.33	0.0716	-56.70
1.20	0.352	-73.9	4.55	126.0	0.0939	-3.80	0.0609	-59.30
1.40	0.347	-84.3	4.42	118.0	0.0953	-5.27	0.0716	-56.10
1.60	0.343	-94.0	4.28	111.0	0.0970	-6.73	0.0711	-56.00
1.80	0.339	-104.0	4.14	103.0	0.0987	-8.30	0.0690	-56.80
2.00	0.335	-114.0	4.01	95.8	0.1000	-10.30	0.0638	-45.50
2.20	0.333	-126.0	3.89	88.7	0.1020	-12.80	0.0569	-43.40
2.40	0.331	-135.0	3.76	81.7	0.1030	-14.20	0.0492	-39.00
2.60	0.330	-145.0	3.64	74.7	0.1040	-16.00	0.0425	-29.80
2.80	0.331	-157.0	3.53	67.9	0.1060	-18.60	0.0373	-15.10
3.00	0.329	-165.0	3.42	61.2	0.1080	-20.50	0.0348	2.19

Typical Test Data

S-Parameters (V_{ds} = 4.5 V, I_{ds} = 50 mA, T = 25°C, unmatched device in a 50 ohm system)

Freq (GHz)	S11 (Mag)	S11 (Ang)	S21 (Mag)	S21 (Ang)	S12 (Mag)	S12 (Ang)	S22 (Mag)	S22 (Ang)
0.05	0.497	-33.54	6.31	165.000	0.081	26.500	0.245	-55.200
0.10	0.359	-31.07	5.69	167.000	0.090	13.900	0.141	-62.700
0.80	0.356	-58.63	5.14	145.000	0.093	-3.827	0.068	-68.122
1.00	0.353	-69.93	5.04	136.685	0.094	-6.032	0.066	-68.389
1.20	0.357	-82.99	4.93	128.643	0.095	-8.283	0.063	-68.067
1.40	0.362	-94.25	4.80	120.939	0.095	-10.605	0.059	-74.252
1.60	0.369	-104.73	4.67	113.721	0.097	-13.182	0.057	-77.789
1.80	0.377	-114.51	4.53	106.633	0.098	-15.567	0.050	-81.883
2.00	0.386	-123.30	4.35	99.630	0.098	-17.516	0.042	-85.216
2.20	0.393	-132.24	4.21	92.751	0.098	-19.753	0.030	-90.110
2.40	0.398	-141.69	4.11	86.006	0.099	-22.503	0.018	-101.088
2.60	0.406	-149.76	4.00	79.363	0.099	-25.083	0.013	160.913
3.00	0.407	-167.94	3.76	66.206	0.100	-30.072	0.028	126.536