



MH204

High Dynamic Range Cellular Band MMIC Mixer

The Communications Edge™

Advanced Product Information

Product Features

- +30 dBm IIP3
- RF 890 – 960 MHz
- LO 1190 – 1310 MHz
- IF 300 – 350 MHz
- +17 dBm Drive Level
- Low Cost SOIC-8 Package
- No External Bias Required

Product Description

The MH204 is a passive GaAs MESFET mixer that provides high dynamic range performance in a low cost SOIC-8 package. WJ's MH204 uses patented techniques to realize greater than +30 dBm Input IP3 at an LO drive level of +17 dBm when used in a simple application circuit as an upconverting or downconverting configuration. This single monolithic integrated circuit does not require any external baluns or bias elements.

Typical applications include frequency up/down conversion, modulation and demodulation for receivers and transmitters used in 2.5G and 3G systems using the cellular and GSM frequency bands.

Functional Diagram

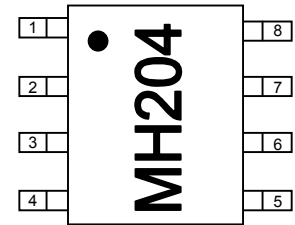

| Function | Pin No. |
|----------|-----------|
| LO | 2 |
| IF & RF* | 5 |
| GND | 1,3,4,6,8 |

* 4 external components (inductors & capacitors) are required to diplex the signal

Specifications

| Parameters ¹ | Units | Minimum | Typical | Maximum | Comments |
|-------------------------|-------|---------|---------|---------|----------|
| Frequency Range: | | | | | |
| RF | MHz | 890 | | 960 | |
| LO | MHz | 1190 | | 1310 | |
| IF | MHz | 300 | | 350 | |
| SSB Conversion Loss | dB | | 9.0 | 9.5 | |
| Noise Figure | dB | | 9.5 | | |
| Input IP3 ² | dBm | | +30 | | |
| Input P1dB | dBm | | TBD | | |
| Isolation: | | | | | |
| L-R | dB | | 25 | | |
| L-I | dB | | 50 | | |
| R-I | dB | | TBD | | |
| Return Loss: | dB | | | | |
| LO Port | | | -8 | | |
| LO Drive Level | dBm | | +17 | | |

1. Data was taken using an application board shown on the following page, with a high side LO at +17 dBm in an downconverting application at 25°C.
 2. Input IP3 was measured with two tones with an input power of -5 dBm / tone separated by 1 MHz.

Absolute Maximum Rating³

| Parameters | Rating |
|-------------------------------------|-----------------|
| Operating Case Temperature | -40° to +85 °C |
| Storage Temperature | -65° to +100 °C |
| Maximum Input LO Power ⁴ | +21 dBm |

3. Operation of this device above any of these parameters may cause permanent damage.
 4. Total sum of LO port and RF port power should not to exceed +23 dBm.

Application Circuit

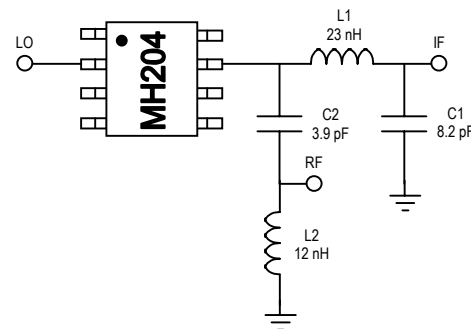

All components are of size 0402



MH204

High Dynamic Range Cellular Band MMIC Mixer

OUTLINE DRAWING

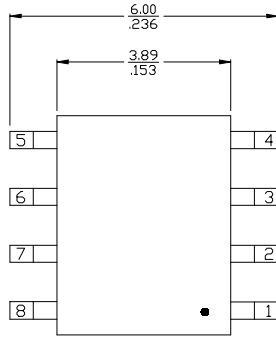

TOP VIEW

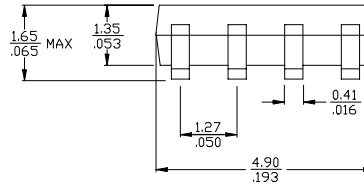
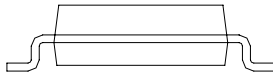

mm
inch

LAND PATTERN

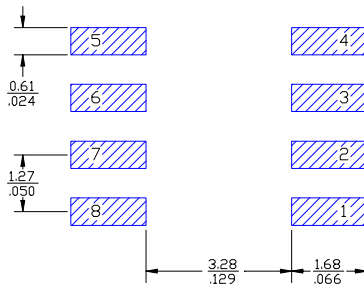

| FUNCTION | PIN NO. |
|----------|---------|
| GROUND | 1 |
| LD | 2 |
| GROUND | 3-6 |
| RF & IF | 7 |
| GROUND | 8 |

MOUNTING CONFIGURATION

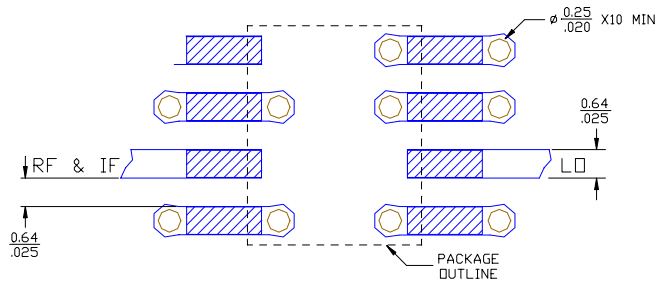

- Notes:
1. Ground vias are critical for thermal and RF grounding considerations.
 2. A minimum of 10 ground vias are required for 14 mil and 28 mil FR4 board.
 3. If your PCB design rules allow, ground vias should be placed under the land pattern for better RF and thermal performance. Otherwise ground vias should be placed as close to land pattern as possible.
 4. Trace width depends on PC board.

This document contains information on a new product. Specifications and information are subject to change without notice.



Caution! ESD sensitive device.