



SMJ 1001-7B

Quad-Diode Mixer

The Communications Edge™

Preliminary Product Information

Product Features

- Input IP3 +13 dBm
- RF Freq 500 - 1000 MHz
- LO Freq 500 - 1000 MHz
- IF Freq DC - 500 MHz
- LO Drive Level +7 dBm

Functional Diagram

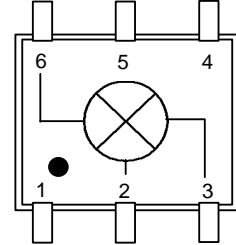

Function	Pin No.
Ground	1
IF	2
RF	3
Ground	4-5
LO	6

Specifications

Parameters	Units	Minimum	Typical	Maximum	Comments
RF Frequency	MHz	500		1000	
LO Frequency	MHz	500		1000	
IF Frequency	MHz	DC		500	
SSB Conversion Loss	dB		7.0		
L-R Isolation	dB		32		
L-I Isolation	dB		26		
IIP3	dBm		+13		
LO Drive	dBm		+7		
RF - Return Loss	dB		11		
LO - Return Loss	dB		14		
IF - Return Loss	dB		11		

Test conditions unless otherwise noted
 1. Tested in a 50 Ohm System, low Side LO.

Recommended Maximum Rating

Parameters	Rating
Operating Case Temperature	-40 to +70 °C
Storage Temperature	-65 to +100 °C
RF Input Power at 25°C (continuous)	+13 dBm

Ordering Information

Part No.	Description
SMJ 1001-7B	Diode Mixer (Available in Tape & Reel)
SMJ 1001-7B-PCB	Fully Assembled Application Circuit

This document contains information on a new product.
 Specifications and information are subject to change without notice



SMJ 1001-7B

Quad-Diode Mixer

The Communications Edge™

Preliminary Product Information

OUTLINE DRAWING

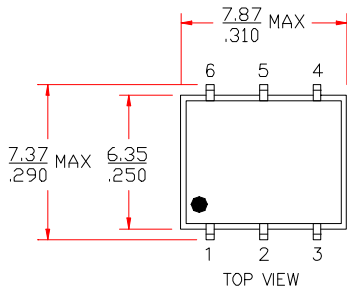

mm
inch

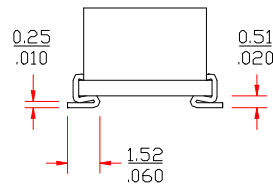
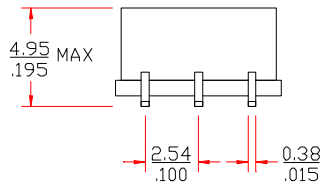
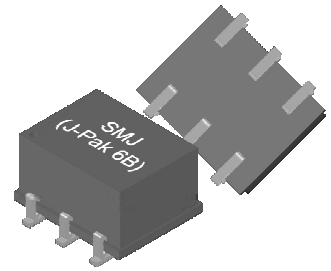

LAND PATTERN

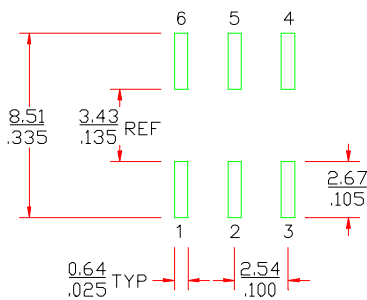

MOUNTING CONFIGURATION

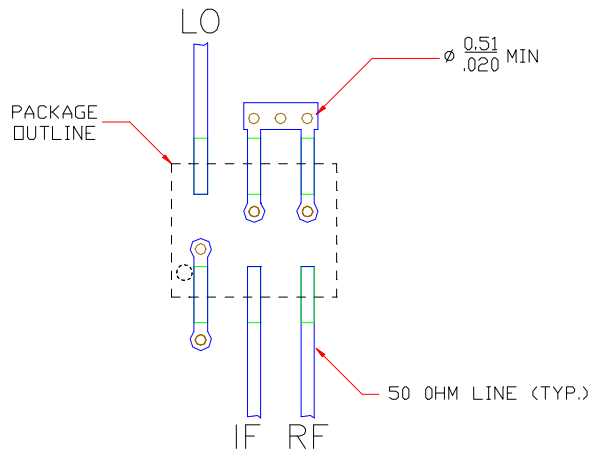

FUNCTION	PIN NO.
GROUND	1
IF	2
RF	3
GROUND	4-5
LO	6

- Notes:
1. Ground vias are critical for RF grounding considerations.
 2. If your PCB design rules allow, ground vias should be placed under the land pattern for better RF performance. Otherwise ground vias should be placed as close land pattern as possible.
 3. Trace width depends on PC board.

This document contains information on a new product. Specifications and information are subject to change without notice.