

### Features

- Diffused Junction
- Low Forward Voltage Drop
- High Current Capability
- High Reliability
- High Surge Current Capability

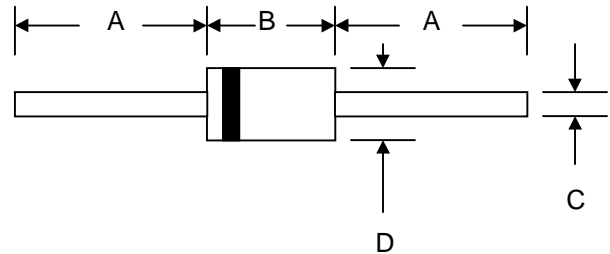

### Mechanical Data

- Case: Molded Plastic
- Terminals: Plated Leads Solderable per MIL-STD-202, Method 208
- Polarity: Cathode Band
- Weight: 1.2 grams (approx.)
- Mounting Position: Any
- Marking: Type Number

DO-201AD		
Dim	Min	Max
A	25.4	—
B	8.50	9.50
C	1.20	1.30
D	5.0	5.60
All Dimensions in mm		

### Maximum Ratings and Electrical Characteristics @ $T_A=25^\circ\text{C}$ unless otherwise specified

Single Phase, half wave, 60Hz, resistive or inductive load.  
 For capacitive load, derate current by 20%.

Characteristic	Symbol	SF51	SF52	SF53	SF54	SF55	SF56	SF57	Unit
Peak Repetitive Reverse Voltage	$V_{RRM}$	50	100	150	200	300	400	600	V
Working Peak Reverse Voltage	$V_{RWM}$								
DC Blocking Voltage	$V_R$								
RMS Reverse Voltage	$V_{R(RMS)}$	35	70	105	140	210	280	420	V
Average Rectified Output Current (Note 1) @ $T_A = 50^\circ\text{C}$	$I_O$	5.0							A
Non-Repetitive Peak Forward Surge Current 8.3ms Single half sine-wave superimposed on rated load (JEDEC Method)	$I_{FSM}$	150							A
Forward Voltage @ $I_F = 5.0\text{A}$	$V_{FM}$	0.95			1.3		1.7		V
Peak Reverse Current @ $T_A = 25^\circ\text{C}$ At Rated DC Blocking Voltage @ $T_A = 100^\circ\text{C}$	$I_{RM}$	5.0				100			$\mu\text{A}$
Reverse Recovery Time (Note 2)	$t_{rr}$	35							nS
Typical Junction Capacitance (Note 3)	$C_j$	110				50			pF
Operating Temperature Range	$T_j$	-65 to +125							$^\circ\text{C}$
Storage Temperature Range	$T_{STG}$	-65 to +150							$^\circ\text{C}$

#### \*Glass passivated forms are available upon request

- Note: 1. Leads maintained at ambient temperature at a distance of 9.5mm from the case  
 2. Measured with  $I_F = 0.5\text{A}$ ,  $I_R = 1.0\text{A}$ ,  $I_{RR} = 0.25\text{A}$ . See figure 5.  
 3. Measured at 1.0 MHz and applied reverse voltage of 4.0V D.C.

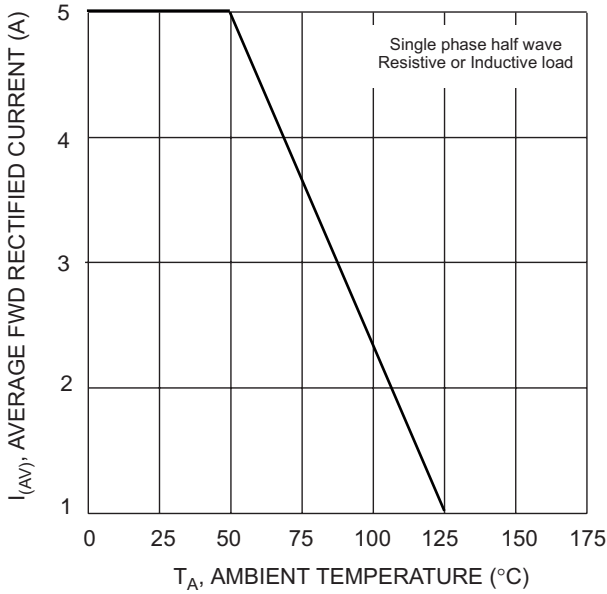

Fig. 1 Forward Current Derating Curve

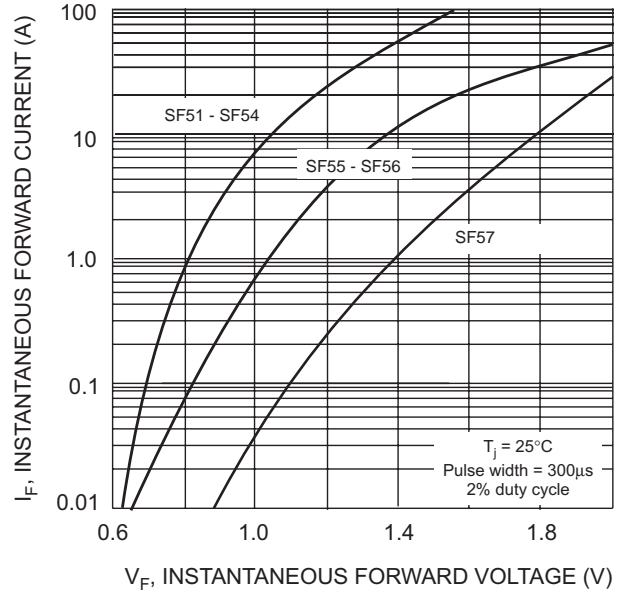

Fig. 2 Typical Forward Characteristics

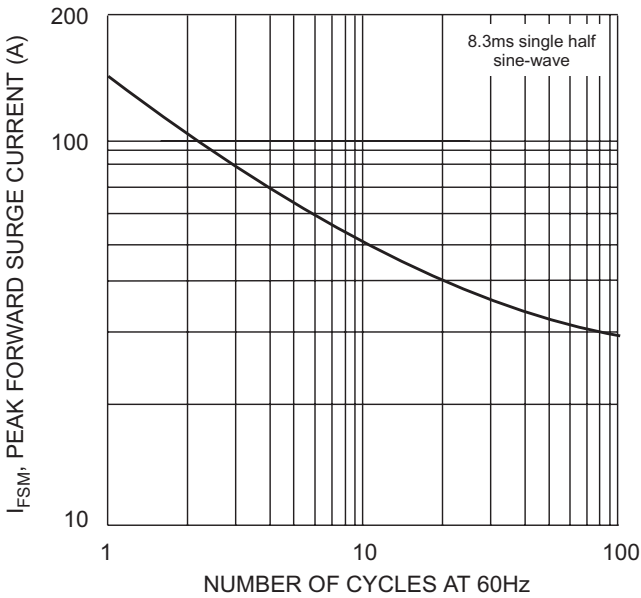

Fig. 3 Peak Forward Surge Current

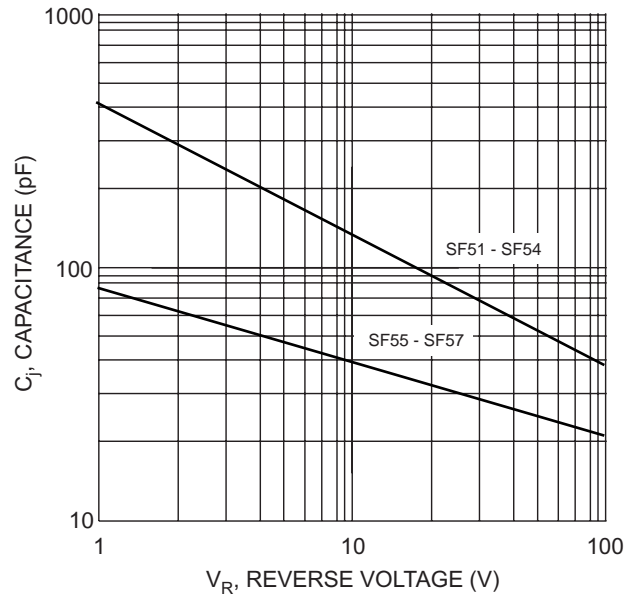
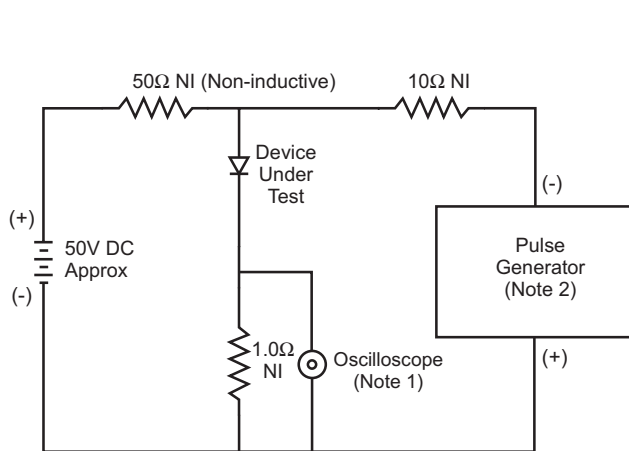
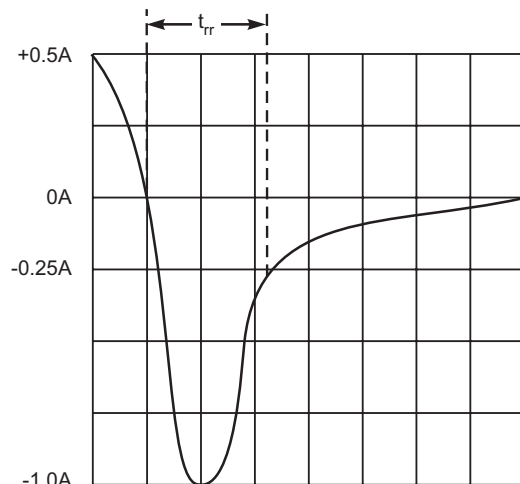

Fig. 4 Typical Junction Capacitance



- Notes:
1. Rise Time = 7.0ns max. Input Impedance = 1.0MΩ, 22pF.
  2. Rise Time = 10ns max. Input Impedance = 50Ω.



Set time base for 5/10ns/cm

Fig. 5 Reverse Recovery Time Characteristic and Test Circuit

## ORDERING INFORMATION

Product No.◆	Package Type	Shipping Quantity
SF51-T3	DO-201AD	1200/Tape & Reel
<b>SF51-TB</b>	DO-201AD	1200/Tape & Box
SF51	DO-201AD	500 Units/Box
SF52-T3	DO-201AD	1200/Tape & Reel
<b>SF52-TB</b>	DO-201AD	1200/Tape & Box
SF52	DO-201AD	500 Units/Box
SF53-T3	DO-201AD	1200/Tape & Reel
<b>SF53-TB</b>	DO-201AD	1200/Tape & Box
SF53	DO-201AD	500 Units/Box
SF54-T3	DO-201AD	1200/Tape & Reel
<b>SF54-TB</b>	DO-201AD	1200/Tape & Box
SF54	DO-201AD	500 Units/Box
SF55-T3	DO-201AD	1200/Tape & Reel
<b>SF55-TB</b>	DO-201AD	1200/Tape & Box
SF55	DO-201AD	500 Units/Box
SF56-T3	DO-201AD	1200/Tape & Reel
<b>SF56-TB</b>	DO-201AD	1200/Tape & Box
SF56	DO-201AD	500 Units/Box
SF57-T3	DO-201AD	1200/Tape & Reel
<b>SF57-TB</b>	DO-201AD	1200/Tape & Box
SF57	DO-201AD	500 Units/Box

Products listed in **bold** are WTE **Preferred** devices.

◆T3 suffix refers to a 13" reel. TB suffix refers to Ammo Pack.

Shipping quantity given is for minimum packing quantity only. For minimum order quantity, please consult the Sales Department.

Won-Top Electronics Co., Ltd (WTE) has checked all information carefully and believes it to be correct and accurate. However, WTE cannot assume any responsibility for inaccuracies. Furthermore, this information does not give the purchaser of semiconductor devices any license under patent rights to manufacturer. WTE reserves the right to change any or all information herein without further notice.

**WARNING: DO NOT USE IN LIFE SUPPORT EQUIPMENT.** WTE power semiconductor products are not authorized for use as critical components in life support devices or systems without the express written approval.

**Won-Top Electronics Co., Ltd.**

No. 44 Yu Kang North 3rd Road, Chine Chen Dist., Kaohsiung, Taiwan

**Phone:** 886-7-822-5408 or 886-7-822-5410

**Fax:** 886-7-822-5417

**Email:** sales@wontop.com

**Internet:** http://www.wontop.com

*We power your everyday.*