

250V P-CHANNEL ENHANCEMENT MODE MOSFET

SUMMARY

$V_{(BR)DSS}=-250V$; $R_{DS(ON)}=14\Omega$; $I_D=-265mA$

DESCRIPTION

This 250V enhancement mode N-channel MOSFET provides users with a competitive specification offering efficient power handling capability, high impedance and is free from thermal runaway and thermally induced secondary breakdown. Applications benefiting from this device include a variety of Telecom and general high voltage circuits.

SOT89 and SOT23-6 versions are also available.

FEATURES

- High voltage
- Low on-resistance
- Fast switching speed
- Low gate drive
- Low threshold
- Complementary P-channel Type ZVN4525G
- SOT223 package

APPLICATIONS

- Earth Recall and dialling switches
- Electronic hook switches
- High Voltage Power MOSFET Drivers
- Telecom call routers
- Solid state relays

ORDERING INFORMATION

DEVICE	REEL SIZE (inches)	TAPE WIDTH (mm)	QUANTITY PER REEL
ZVP4525GTA	7	8mm embossed	1000 units
ZVP4525GTC	13	8mm embossed	4000 units

DEVICE MARKING

- ZVP4525G

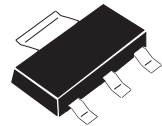

SOT223

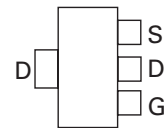
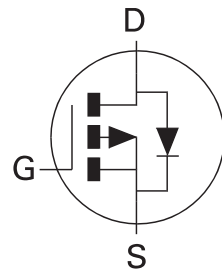

Top View

ZVP4525G

ABSOLUTE MAXIMUM RATINGS.

PARAMETER	SYMBOL	LIMIT	UNIT
Drain-Source Voltage	V_{DSS}	250	V
Gate Source Voltage	V_{GS}	± 40	V
Continuous Drain Current ($V_{GS}=10V$; $T_A=25^\circ C$)(a) ($V_{GS}=10V$; $T_A=70^\circ C$)(a)	I_D I_{DM}	-265 -212	mA mA
Pulsed Drain Current (c)	I_{DM}	-1	A
Continuous Source Current (Body Diode)	I_S	-0.75	A
Pulsed Source Current (Body Diode)	I_{SM}	-1	A
Power Dissipation at $T_A=25^\circ C$ (a) Linear Derating Factor	P_D	2 16	W mW/ $^\circ C$
Operating and Storage Temperature Range	$T_j; T_{stg}$	-55 to +150	$^\circ C$

THERMAL RESISTANCE

PARAMETER	SYMBOL	VALUE	UNIT
Junction to Ambient (a)	$R_{\theta JA}$	63	$^\circ C/W$
Junction to Ambient (b)	$R_{\theta JA}$	26	$^\circ C/W$

NOTES

- (a) For a device surface mounted on 25mm x 25mm FR4 PCB with high coverage of single sided 1oz copper, in still air conditions
- (b) For a device surface mounted on FR4 PCB measured at $t \leq 5$ secs.
- (c) Repetitive rating - pulse width limited by maximum junction temperature. Refer to Transient Thermal Impedance graph.

NB High Voltage Applications

For high voltage applications, the appropriate industry sector guidelines should be considered with regard to voltage spacing between conductors.

CHARACTERISTICS

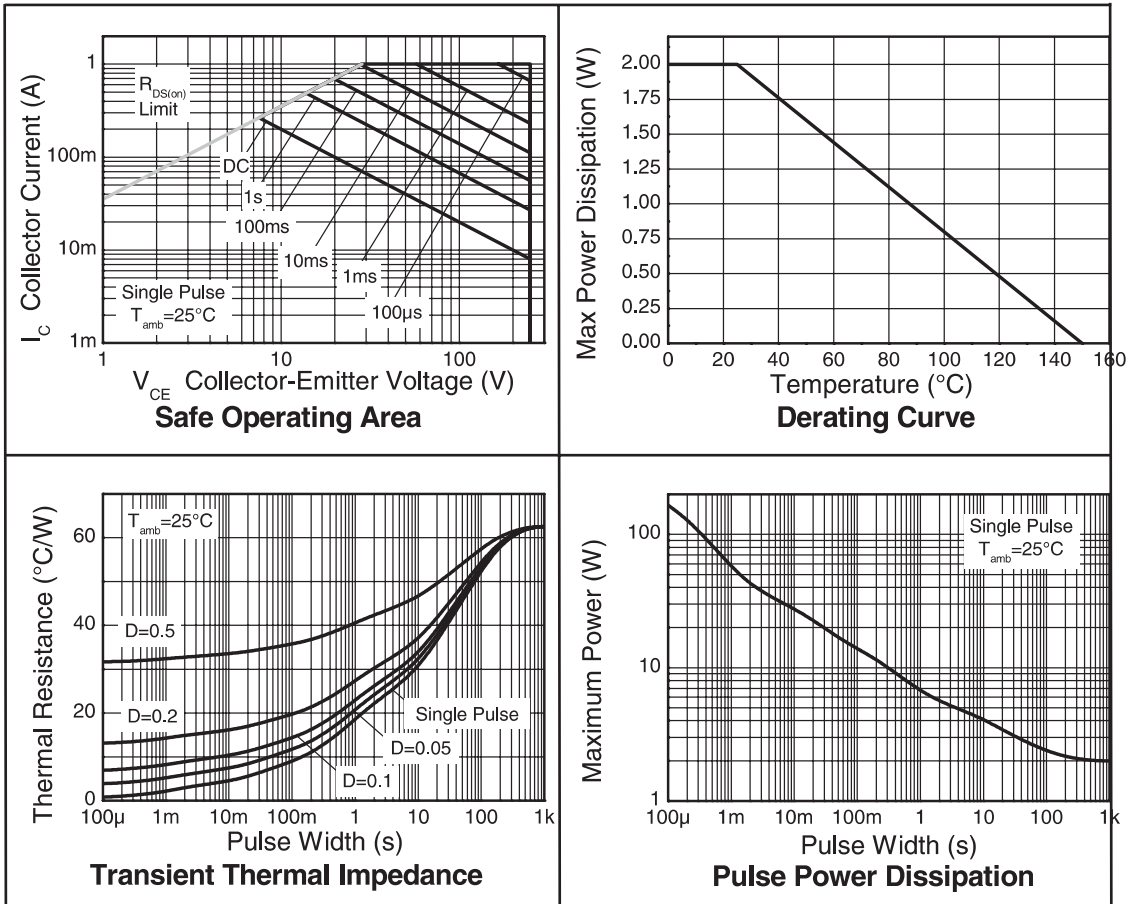

ZVP4525G

ELECTRICAL CHARACTERISTICS (at $T_{amb} = 25^{\circ}\text{C}$ unless otherwise stated).

PARAMETER	SYMBOL	MIN.	TYP.	MAX.	UNIT	CONDITIONS.
STATIC						
Drain-Source Breakdown Voltage	$V_{(BR)DSS}$	-250	-285		V	$I_D = -1\text{mA}, V_{GS} = 0\text{V}$
Zero Gate Voltage Drain Current	I_{DSS}		-30	-500	nA	$V_{DS} = -250\text{V}, V_{GS} = 0\text{V}$
Gate-Body Leakage	I_{GSS}		± 1	± 100	nA	$V_{GS} = \pm 40\text{V}, V_{DS} = 0\text{V}$
Gate-Source Threshold Voltage	$V_{GS(th)}$	-0.8	-1.5	-2.0	V	$I_D = -1\text{mA}, V_{DS} = V_{GS}$
Static Drain-Source On-State Resistance (1)	$R_{DS(on)}$		10 13	14 18	Ω Ω	$V_{GS} = -10\text{V}, I_D = -200\text{mA}$ $V_{GS} = -3.5\text{V}, I_D = -100\text{mA}$
Forward Transconductance (3)	g_{fs}	80	200		mS	$V_{DS} = -10\text{V}, I_D = -0.15\text{A}$
DYNAMIC (3)						
Input Capacitance	C_{iss}		73		pF	$V_{DS} = -25\text{V}, V_{GS} = 0\text{V},$ $f = 1\text{MHz}$
Output Capacitance	C_{oss}		12.8		pF	
Reverse Transfer Capacitance	C_{rss}		3.91		pF	
SWITCHING(2) (3)						
Turn-On Delay Time	$t_{d(on)}$		1.53		ns	$V_{DD} = -30\text{V}, I_D = -200\text{mA}$ $R_G = 50\Omega, V_{GS} = -10\text{V}$ (refer to test circuit)
Rise Time	t_r		3.78		ns	
Turn-Off Delay Time	$t_{d(off)}$		17.5		ns	
Fall Time	t_f		7.85		ns	
Total Gate Charge	Q_g		2.45	3.45	nC	$V_{DS} = -25\text{V}, V_{GS} = -10\text{V},$ $I_D = -200\text{mA}$ (refer to test circuit)
Gate-Source Charge	Q_{gs}		0.22	0.31	nC	
Gate Drain Charge	Q_{gd}		0.45	0.63	nC	
SOURCE-DRAIN DIODE						
Diode Forward Voltage (1)	V_{SD}			0.97	V	$T_j = 25^{\circ}\text{C}, I_S = -200\text{mA},$ $V_{GS} = 0\text{V}$
Reverse Recovery Time (3)	t_{rr}		205	290	ns	$T_j = 25^{\circ}\text{C}, I_F = -200\text{mA},$ $di/dt = 100\text{A}/\mu\text{s}$
Reverse Recovery Charge (3)	Q_{rr}		21	29	nC	

(1) Measured under pulsed conditions. Width=300 μs . Duty cycle $\leq 2\%$.

(2) Switching characteristics are independent of operating junction temperature.

(3) For design aid only, not subject to production testing.

TYPICAL CHARACTERISTICS

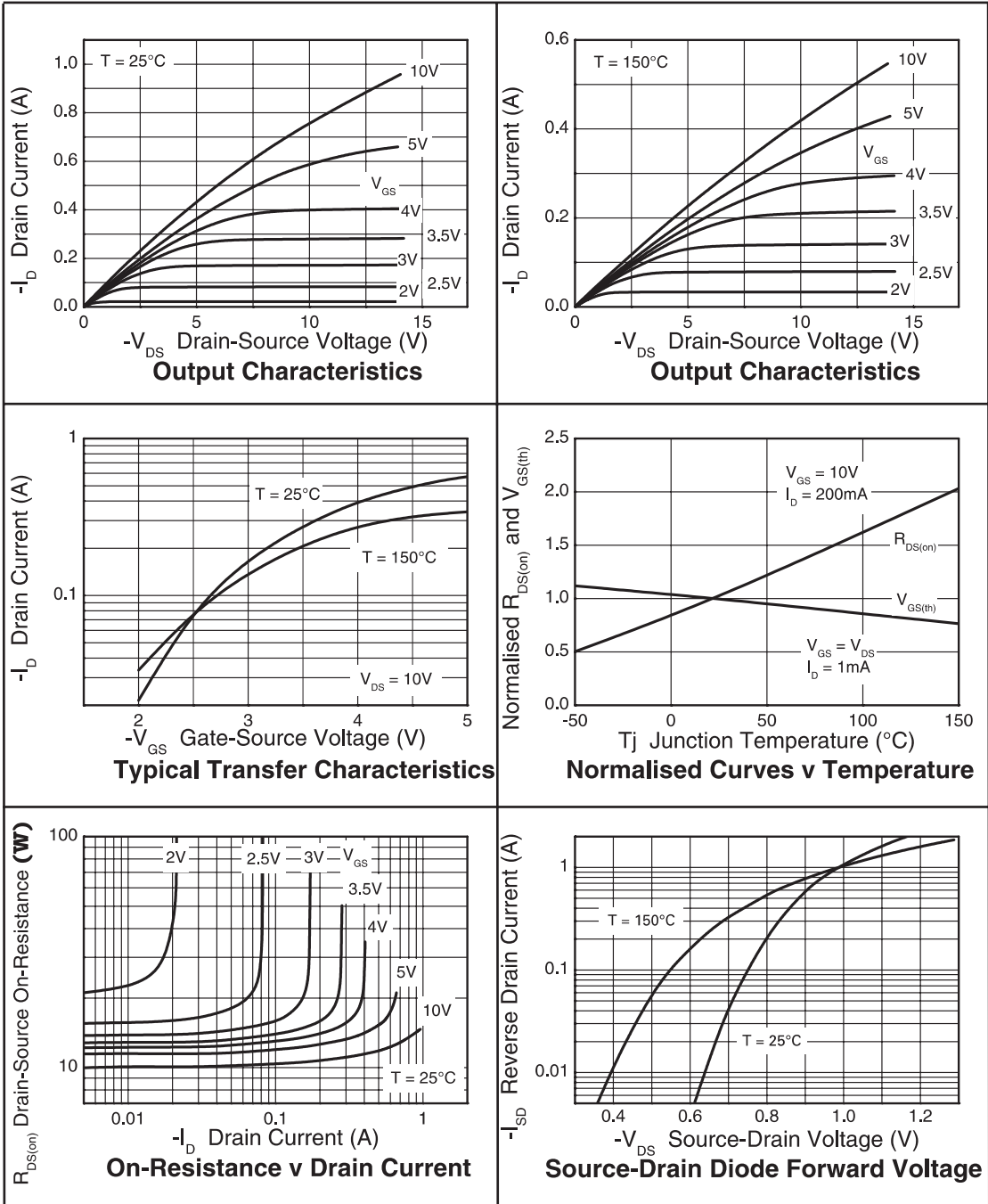

CHARACTERISTICS

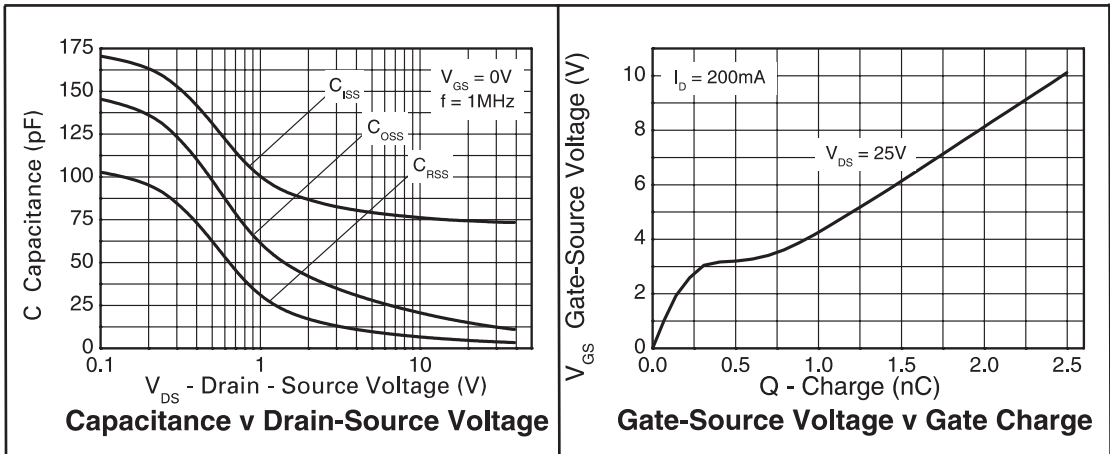

TEST CIRCUITS

ZVP4525G

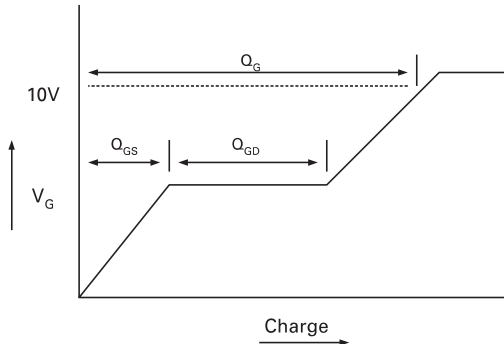

Basic Gate Charge Waveform

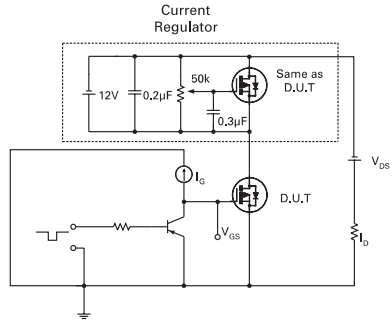

Gate Charge Test Circuit

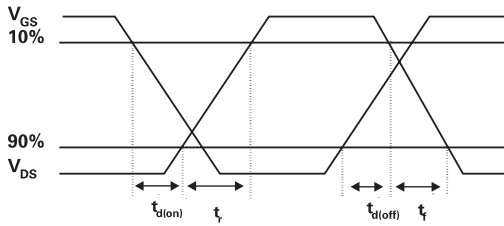

Switching Time Waveforms

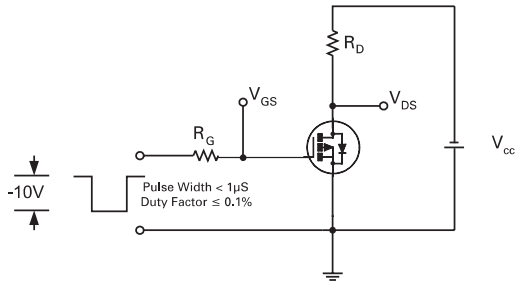

Switching Time Test Circuit

ZVP4525G

PACKAGE DIMENSIONS

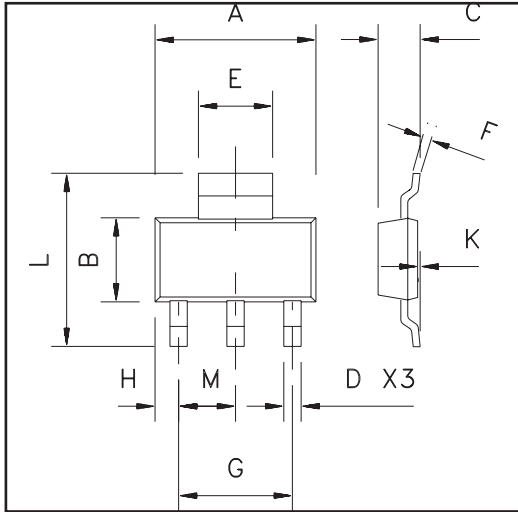

PAD LAYOUT DETAILS

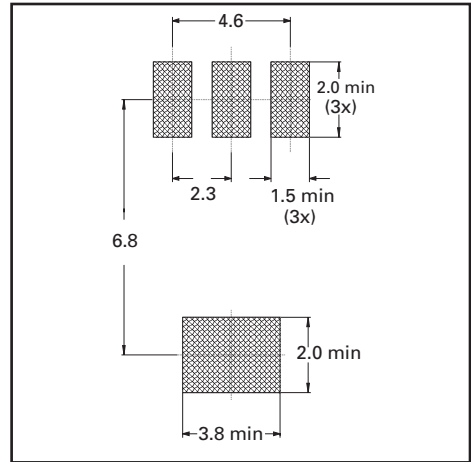

Dim	Millimeters		Inches	
	Min	Max	Min	Max
A	6.3	6.7	0.248	0.264
B	3.3	3.7	0.130	0.146
C	-	1.7	-	0.067
D	0.6	0.8	0.024	0.031
E	2.9	3.1	0.114	0.122
F	0.24	0.32	0.009	0.013
G	NOM 4.6		NOM 0.181	
H	0.85	1.05	0.033	0.041
K	0.02	0.10	0.0008	0.004
L	6.7	7.3	0.264	0.287
M	NOM 2.3		NOM 0.0905	



Zetex plc.
Fields New Road, Chadderton, Oldham, OL9-8NP, United Kingdom.
Telephone: (44)161 622 4422 (Sales), (44)161 622 4444 (General Enquiries)
Fax: (44)161 622 4420

Zetex GmbH
Streitfeldstraße 19
D-81673 München
Germany
Telephone: (49) 89 45 49 49 0
Fax: (49) 89 45 49 49 49

Zetex Inc.
47 Mall Drive, Unit 4
Commack NY 11725
USA
Telephone: (631) 543-7100
Fax: (631) 864-7630

Zetex (Asia) Ltd.
3701-04 Metroplaza, Tower 1
Hing Fong Road,
Kwai Fong, Hong Kong
Telephone: (852) 26100 611
Fax: (852) 24250 494

These are supported by
agents and distributors in
major countries world-wide
© Zetex plc 2000
www.zetex.com

This publication is issued to provide outline information only which (unless agreed by the Company in writing) may not be used, applied or reproduced for any purpose or form part of any order or contract or be regarded as a representation relating to the products or services concerned. The Company reserves the right to alter without notice the specification, design, price or conditions of supply of any product or service.