

ZXMN10A08E6

100V N-CHANNEL ENHANCEMENT MODE MOSFET

SUMMARY

$V_{(BR)DSS} = 100V$; $R_{DS(ON)} = 0.4\Omega$ $I_D = 1.5A$

DESCRIPTION

This new generation of TRENCH MOSFETs from Zetex utilizes a unique structure that combines the benefits of low on-resistance with fast switching speed. This makes them ideal for high efficiency, low voltage, power management applications.

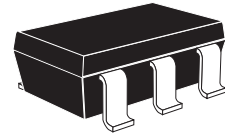

SOT23-6

FEATURES

- Low on-resistance
- Fast switching speed
- Low threshold
- Low gate drive
- SOT23-6 package

APPLICATIONS

- DC - DC Converters
- Power Management Functions
- Disconnect switches
- Motor control

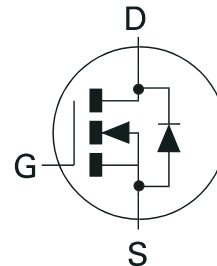

ORDERING INFORMATION

DEVICE	REEL SIZE	TAPE WIDTH	QUANTITY PER REEL
ZXMN10A08E6TA	7"	8mm	3000 units
ZXMN10A08E6TC	13"	8mm	10000 units

DEVICE MARKING

- 10A8

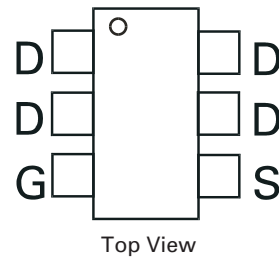

ZXMN10A08E6

ABSOLUTE MAXIMUM RATINGS.

PARAMETER	SYMBOL	LIMIT	UNIT
Drain-Source Voltage	V_{DSS}	100	V
Gate Source Voltage	V_{GS}	± 20	V
Continuous Drain Current $V_{GS}=10V$; $T_A=25^\circ C$ (b) $V_{GS}=10V$; $T_A=70^\circ C$ (b) $V_{GS}=10V$; $T_A=25^\circ C$ (a)	I_D	1.5 1.2 1.21	A
Pulsed Drain Current (c)	I_{DM}	5.3	A
Continuous Source Current (Body Diode) (b)	I_S	2.5	A
Pulsed Source Current (Body Diode) (c)	I_{SM}	5.3	A
Power Dissipation at $T_A=25^\circ C$ (a) Linear Derating Factor	P_D	1.1 8.8	W mW/ $^\circ C$
Power Dissipation at $T_A=25^\circ C$ (b) Linear Derating Factor	P_D	1.7 13.6	W mW/ $^\circ C$
Operating and Storage Temperature Range	$T_j:T_{stg}$	-55 to +150	$^\circ C$

THERMAL RESISTANCE

PARAMETER	SYMBOL	VALUE	UNIT
Junction to Ambient (a)	$R_{\theta JA}$	113	$^\circ C/W$
Junction to Ambient (b)	$R_{\theta JA}$	73	$^\circ C/W$

NOTES

(a) For a device surface mounted on 25mm x 25mm FR4 PCB with high coverage of single sided 1oz copper, in still air conditions

(b) For a device surface mounted on FR4 PCB measured at $t \leq 10$ secs.

(c) Repetitive rating 25mm x 25mm FR4 PCB, $D = 0.05$, pulse width 10 μs - pulse width limited by maximum junction temperature. Refer to Transient Thermal Impedance graph

ZXMN10A08E6

CHARACTERISTICS

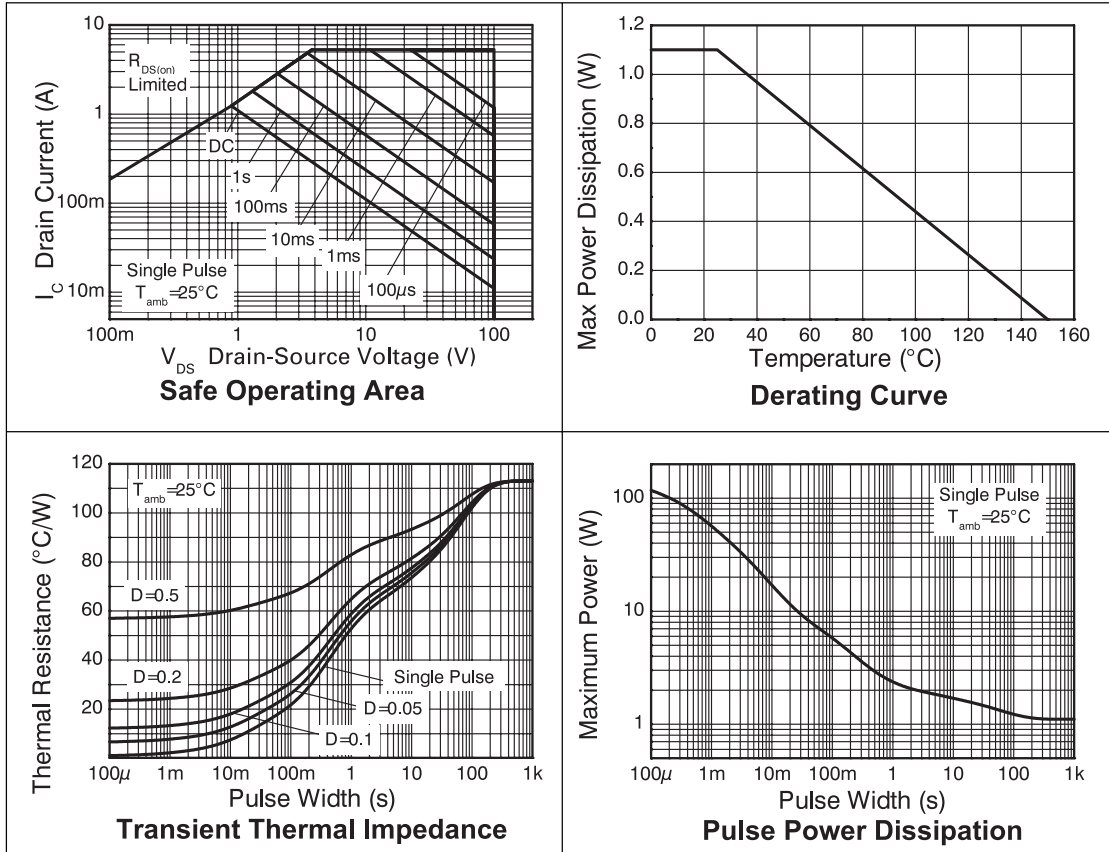

ZXMN10A08E6

ELECTRICAL CHARACTERISTICS (at $T_A = 25^\circ\text{C}$ unless otherwise stated).

PARAMETER	SYMBOL	MIN.	TYP.	MAX.	UNIT	CONDITIONS.
STATIC						
Drain-Source Breakdown Voltage	$V_{(BR)DSS}$	100			V	$I_D=250\mu\text{A}, V_{GS}=0\text{V}$
Zero Gate Voltage Drain Current	I_{DSS}			0.5	μA	$V_{DS}=100\text{V}, V_{GS}=0\text{V}$
Gate-Body Leakage	I_{GSS}			100	nA	$V_{GS}=\pm 20\text{V}, V_{DS}=0\text{V}$
Gate-Source Threshold Voltage	$V_{GS(th)}$	2.0			V	$I_D=250\mu\text{A}, V_{DS}=V_{GS}$
Static Drain-Source On-State Resistance (1)	$R_{DS(on)}$			0.40 0.60	Ω	$V_{GS}=10\text{V}, I_D=3.2\text{A}$ $V_{GS}=6\text{V}, I_D=2.6\text{A}$
Forward Transconductance (1)(3)	g_{fs}		5.0		S	$V_{DS}=15\text{V}, I_D=3.2\text{A}$
DYNAMIC (3)						
Input Capacitance	C_{iss}		405		pF	$V_{DS}=50\text{V}, V_{GS}=0\text{V},$ $f=1\text{MHz}$
Output Capacitance	C_{oss}		28.2		pF	
Reverse Transfer Capacitance	C_{rss}		14.2		pF	
SWITCHING(2) (3)						
Turn-On Delay Time	$t_{d(on)}$		3.4		ns	$V_{DD}=30\text{V}, I_D=1.2\text{A}$ $R_G=6.0\Omega, V_{GS}=10\text{V}$
Rise Time	t_r		2.2		ns	
Turn-Off Delay Time	$t_{d(off)}$		8		ns	
Fall Time	t_f		3.2		ns	
Gate Charge	Q_g		4.2		nC	$V_{DS}=50\text{V}, V_{GS}=5\text{V},$ $I_D=1.2\text{A}$
Total Gate Charge	Q_g		7.7		nC	$V_{DS}=50\text{V}, V_{GS}=10\text{V},$ $I_D=1.2\text{A}$
Gate-Source Charge	Q_{gs}		1.8		nC	
Gate-Drain Charge	Q_{gd}		2.1		nC	
SOURCE-DRAIN DIODE						
Diode Forward Voltage (1)	V_{SD}		0.87	0.95	V	$T_J=25^\circ\text{C}, I_S=3.2\text{A},$ $V_{GS}=0\text{V}$
Reverse Recovery Time (3)	t_{rr}		27		ns	$T_J=25^\circ\text{C}, I_F=1.2\text{A},$ $di/dt=100\text{A}/\mu\text{s}$
Reverse Recovery Charge (3)	Q_{rr}		32		nC	

NOTES

- (1) Measured under pulsed conditions. Width=300 μs . Duty cycle $\leq 2\%$.
- (2) Switching characteristics are independent of operating junction temperature.
- (3) For design aid only, not subject to production testing.

ZXMN10A08E6

TYPICAL CHARACTERISTICS

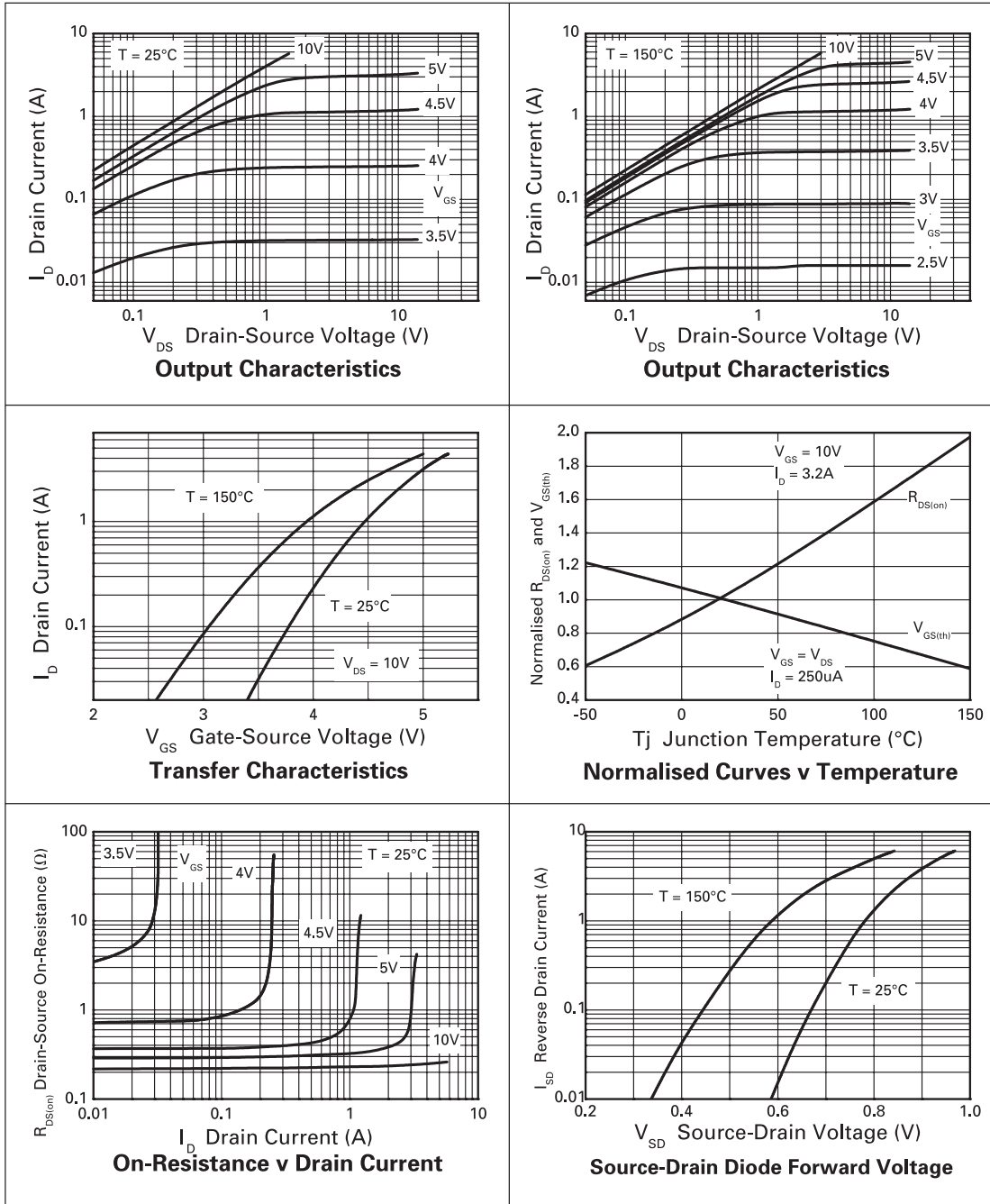

ZXMN10A08E6

TYPICAL CHARACTERISTICS

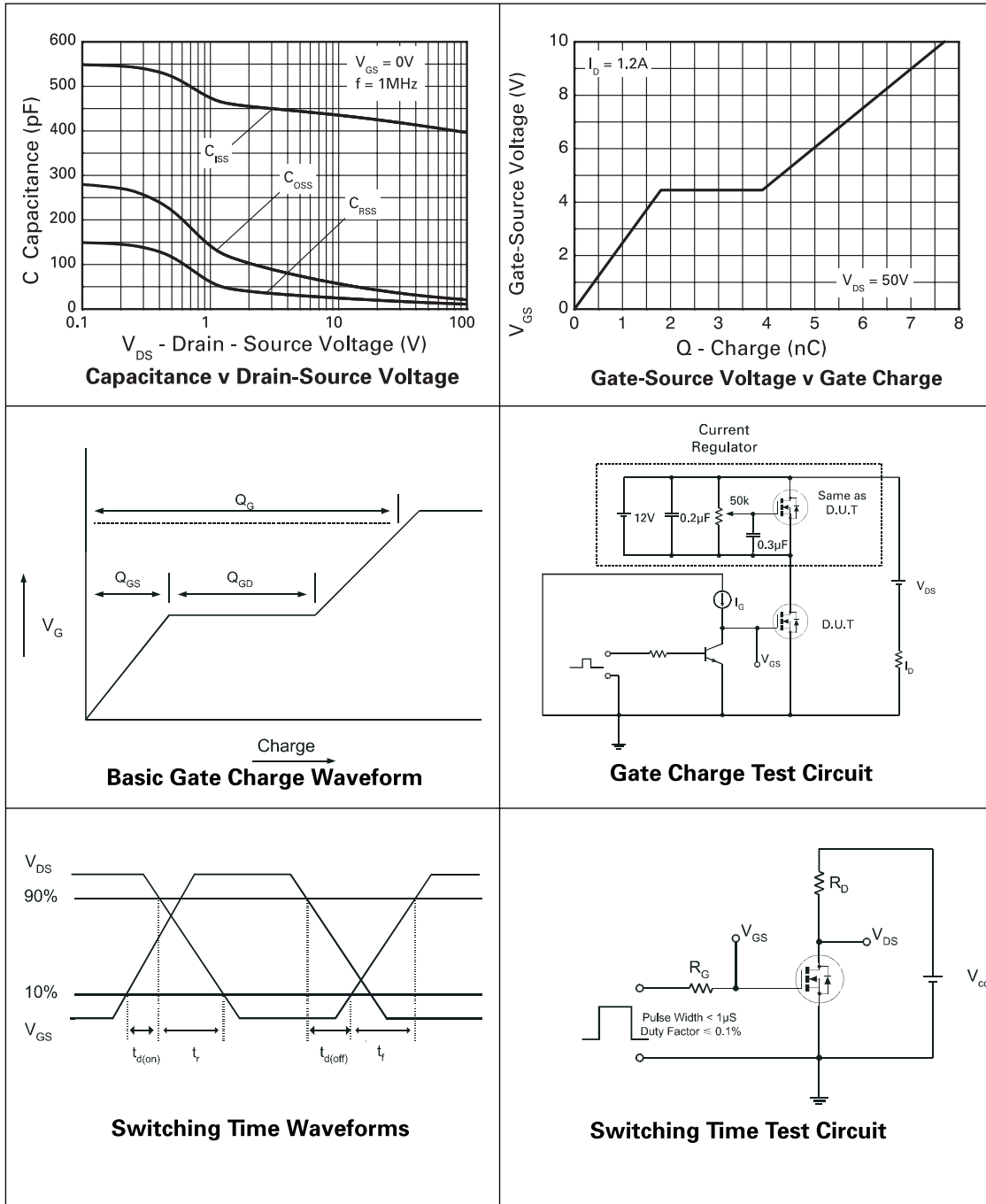

ZXMN10A08E6

PACKAGE DIMENSIONS

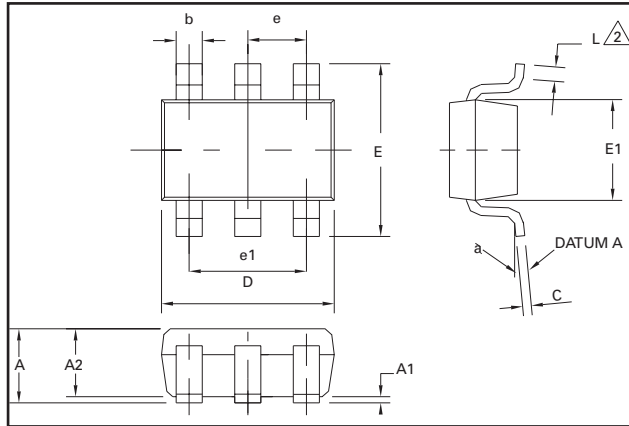

PAD LAYOUT DETAILS

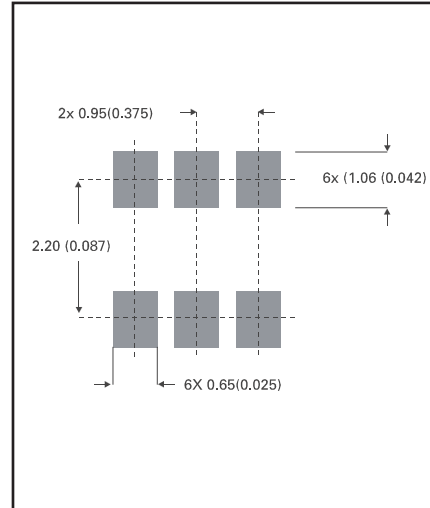

DIM	Millimetres		Inches	
	Min	Max	Min	Max
A	0.90	1.45	0.35	0.057
A1	0.00	0.15	0	0.006
A2	0.90	1.30	0.035	0.051
b	0.35	0.50	0.014	0.019
C	0.09	0.20	0.0035	0.008
D	2.80	3.00	0.110	0.118
E	2.60	3.00	0.102	0.118
E1	1.50	1.75	0.059	0.069
L	0.10	0.60	0.004	0.002
e	0.95 REF		0.037 REF	
e1	1.90 REF		0.074 REF	
L	0°	10°	0°	10°

© Zetex plc 2001

Zetex plc
Fields New Road
Chadderton
Oldham, OL9 8NP
United Kingdom
Telephone (44) 161 622 4422
Fax: (44) 161 622 4420

Zetex GmbH
Streitfeldstraße 19
D-81673 München
Germany
Telefon: (49) 89 45 49 49 0
Fax: (49) 89 45 49 49 49

Zetex Inc
700 Veterans Memorial Hwy
Hauppauge, NY11788
USA
Telephone: (631) 360 2222
Fax: (631) 360 8222

Zetex (Asia) Ltd
3701-04 Metroplaza, Tower 1
Hing Fong Road
Kwai Fong
Hong Kong
Telephone: (852) 26100 611
Fax: (852) 24250 494

These offices are supported by agents and distributors in major countries world-wide.

This publication is issued to provide outline information only which (unless agreed by the Company in writing) may not be used, applied or reproduced for any purpose or form part of any order or contract or be regarded as a representation relating to the products or services concerned. The Company reserves the right to alter without notice the specification, design, price or conditions of supply of any product or service.

For the latest product information, log on to www.zetex.com

ISSUE 1 - MARCH 2002

ZETEX